

2024

INNOVATING FOR YOU



**Movilfrit**



2024

INNOVATING FOR YOU



**Movilfrit**



**FABRICADO EN ESPAÑA**  
MADE IN SPAIN  
FABRIQUÉ EN ESPAGNE

# APP

DESCUBRE NUESTRA  
NUEVA APP

DISCOVER OUR  
NEW APP

DÉCOUVREZ NOTRE  
NOUVELLE APP



 (+34) 936 358 758

 (+34) 608 299 107

 pedidos@movilfritofficial.com

www.movilfritofficial.com

App **movilfritofficial**



Available on the  
**App Store**

GET IT ON  
**Google Play**

## ACCEDA A TODA LA INFORMACION TÉCNICA

Fichas técnicas, esquemas electricos, despieces, manuales de instrucciones, recambios con imágenes y mucho más.

## ACCESS ALL THE TECHNICAL INFORMATION

Technical specifications, electric schemes, exploded views, manuals, spare parts with images and much more.

## ACCÉDER À TOUTES LES INFORMATIONS TECHNIQUES

Spécifications techniques, schémas électriques, vues éclatées, manuels, pièces de rechange avec images et bien plus encore.

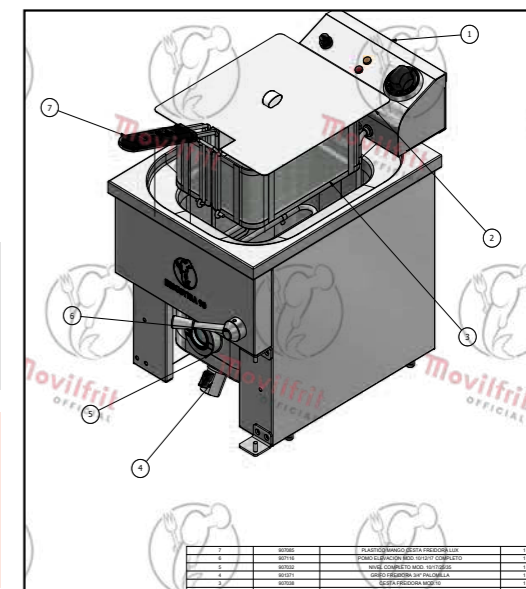

## REALICE SU PEDIDO

Al mandar el pedido recibe una copia para su control.

## PLACE YOUR ORDER

When sending the order you receive a copy for your control.

## PASSER VOTRE COMMANDE

Lors de l'envoi de la commande, vous recevez une copie pour votre contrôle.



## SIEMPRE AL DÍA

Productos y precios siempre actualizados.

## ALWAYS UP TO DATE

Products and prices always updated.

## TOUJOURS À JOUR

Produits et prix toujours mis à jour.



## OFERTAS

Acceso directo a ofertas de producto.

## OFFERS

Direct access to product offers.

## DES OFFRES

Accès direct aux offres des produits.



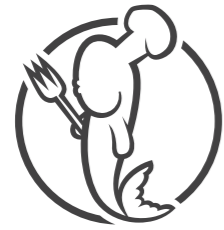

# Movilfrit

## DISEÑO, FABRICACIÓN Y COMERCIALIZACIÓN DE MAQUINARIA DE CALIDAD PARA LA HOSTELERÍA

Desde nuestra fundación en 1962, hemos conseguido llegar hasta hoy diseñando, fabricando y comercializando productos especialmente pensados para dar respuesta a cualquier necesidad que pueda surgir entre los profesionales de la hostelería y de la restauración.

Grandes y medianas empresas e incluso particulares, disponen de nuestra garantía de puntualidad en sus pedidos, entregados en márgenes de tiempo de 48/72h y también en reparación y envío de recambios.

## DESIGN, MANUFACTURE AND MARKETING OF QUALITY MACHINERY FOR THE HOTELRY SECTOR

Since our foundation in 1962, we have managed to reach the present day by designing, manufacturing and marketing products specially designed to meet any need that may arise among professionals in the hotel and catering industry.

Large and medium-sized companies and even private individuals can count on our guarantee of punctuality in their orders, delivered within 48/72 hours and also in the repair and shipment of spare parts.

## CONCEPTION, FABRICACION ET COMMERCIALISATION DE MACHINES DE QUALITÉ POUR L'INDUSTRIE HÔTELIÈRE

Depuis notre fondation en 1962, nous avons réussi à atteindre le jour d'aujourd'hui en concevant, fabriquant et commercialisant des produits spécialement conçus pour répondre à tous les besoins des professionnels de l'hôtellerie et de la restauration.

Les grandes et moyennes entreprises et même les particuliers peuvent compter sur notre garantie de ponctualité dans leurs commandes, livrées dans les 48/72 heures, ainsi que dans la réparation.

## SOMOS FABRICANTES

Todos nuestros productos están fabricados en España -Sant Boi de Llobregat (Barcelona)-, con la mejor tecnología, los mejores materiales y sin obsolescencia programada, ya que todos nuestros productos están diseñados para perdurar.

Vitrinas, planchas y freidoras con sistema agua-aceite -tecnología de la que somos pioneros- o freidoras de sólo aceite, se incluyen en nuestro amplio catálogo con diseños a medida y personalización total para nuestro cliente.

Llevamos 60 años ofreciendo soluciones en materia de equipamiento integral de cocina profesional. La tecnología aplicada a nuestros procesos, la exhaustiva selección de los mejores materiales, el alto grado de profesionalidad y la amplia experiencia de nuestro personal, son algunas de las claves que nos han llevado a ser considerados como referente en el sector, tanto a nivel nacional como internacional.

## WE ARE MANUFACTURERS

All our products are manufactured in Spain -Sant Boi de Llobregat (Barcelona)-, with the best technology, the best materials and without programmed obsolescence, as all our products are designed to last.

Display cabinets, griddles and fryers with water-oil system - a technology in which we are pioneers - or oil-only fryers, are included in our extensive catalogue with customised designs and total personalisation for our customers.

We have been offering solutions for 60 years in terms of integral professional kitchen equipment. The technology applied to our processes, the exhaustive selection of the best materials, the high degree of professionalism and the extensive experience of our staff, are some of the keys that have led us to be considered as a reference in the sector, both nationally and internationally.

## NOUS SOMMES DES FABRICANTS

Tous nos produits sont fabriqués en Espagne -Sant Boi de Llobregat (Barcelona)-, avec la meilleure technologie, les meilleurs matériaux et sans obsolescence programmée, car tous nos produits sont conçus pour durer.

Vitrines, plancha et friteuses avec système eau-huile - une technologie dans laquelle nous sommes pionniers - ou friteuses uniquement à l'huile, font partie de notre vaste catalogue avec des designs sur mesure et une personnalisation totale pour nos clients.

Depuis 60 ans, nous proposons des solutions en matière d'équipement intégral de cuisine professionnelle. La technologie appliquée à nos processus, la sélection exhaustive des meilleurs matériaux, le haut degré de professionnalisme et la grande expérience de notre personnel, sont quelques-unes des clés qui nous ont permis d'être considérés comme une référence dans le secteur, tant au niveau national qu'international.

6



FREIDORAS  
FRYERS  
FRITEUSES

42



VITRINAS  
DISPLAY CASES  
VITRINES

72



BRASA  
CHARCOAL  
BRAISE

80



MODULAR  
MODULAR  
MODULARIE

86



PLANCHAS  
GRIDDLES  
PLANCHAS

96



COCINAS  
KITCHENS  
CUISINIÈRES

100



BARBACOAS  
BARBACUE  
BARBECUES

104



TOSTADORES  
TOASTERS  
GRILLEPAIN

110



MICROONDAS  
MICROWAVES  
MICRO-ONDES

114



DOMESTICO  
DOMESTIC  
DOMESTIQUE

120



RECAMBIOS  
SPARE PARTS  
PIÈCES DÉTACHÉES





## FREIDORAS

14-23 ECONÓMICAS

24-31 ACEITE

32-33 ECONÓMICAS  
AGUA-ACEITE

34-37 AGUA-ACEITE

38-41 GAS

## FRYERS

14-23 ECONOMIC

24-31 OIL

32-33 ECONOMIC  
WATER-OIL

34-37 WATER-OIL

38-41 GAS

## FRITEUSES

14-23 ÉCONOMIQUES

24-31 HUILE

32-33 ÉCONOMIQUES  
EAU-HUILE

34-37 EAU-HUILE

38-41 GAZ





## SISTEMA ACEITE

En este tipo de freidora, los residuos permanecen revoloteando por el aceite por lo que al freír distintos alimentos se mezclan los sabores y deben ser evacuados mediante su filtraje.

El atractivo de este sistema está en su sencillez, puesto que no se utiliza agua. Los restos de los alimentos se depositan en la parte inferior estando siempre en contacto con el aceite.

## OIL SYSTEM

In this type of fryer, the residues remain fluttering through the oil, so when frying different foods, the flavors mix and must be evacuated by filtering.

The appeal of this system stays in his simplicity, since no water is used. The remains of the food are deposited in the lower part and always being in contact with the oil.

## SYSTÈME D'HUILE

Dans ce type de friteuse, les résidus flottent toujours dans l'huile, de sorte que lorsque vous faites frire différents aliments, les saveurs se mélangent et doivent être évacués par filtration.

L'attrait de ce système réside dans sa simplicité, puisqu'aucune eau n'est utilisée. Les restes de la nourriture sont déposés dans la part inférieure, étant toujours en contact avec l'huile.

## SISTEMA AGUA Y ACEITE

En estas freidoras, los restos de los alimentos que se desprenden durante la fritura, atraviesan el aceite y se depositan en la capa de agua en el fondo de la cuba. Estos residuos son evacuados conjuntamente con el agua. Esta operación se realizará diariamente con el aceite a temperatura ambiente.

En las freidoras que incorporan este sistema exclusivo, el agua se deposita en la parte inferior de la cuba por diferencia de densidad haciendo de filtro permanente. De esta manera freímos distintos tipos de alimentos sin que la freidora mezcle sabores y conseguimos un **gran ahorro de aceite**.

## WATER & OIL SYSTEM

In these fryers, the remains of the food that come off during frying pass through the oil and are deposited in the layer of water at the bottom of the tank. These residues are evacuated with the water. This operation will be carried out daily with the oil at room temperature.

In fryers that incorporated this exclusive system, the water is deposited in the lower part of the tank due to a difference in density, acting as a permanent filter. In this way, we fry different types of food without the fryer mixing flavors and achieving **great savings in oil**.

## SYSTÈME EAU & HUILE

Dans ces friteuses, les restes d'aliments qui se détachent lors de la friture, traversent l'huile et se déposent dans la couche d'eau au fond de la cuve. Ces résidus sont évacués avec l'eau. Cette opération sera effectuée quotidiennement avec l'huile à température ambiante.

Dans les friteuses qui intègrent ce système exclusif, l'eau se dépose dans la partie inférieure du réservoir en raison d'une différence de densité, agissant comme un filtre permanent. De cette façon, on fait frire différents types d'aliments sans que la friteuse mélange les saveurs et réalisant de **grandes économies d'huile**.

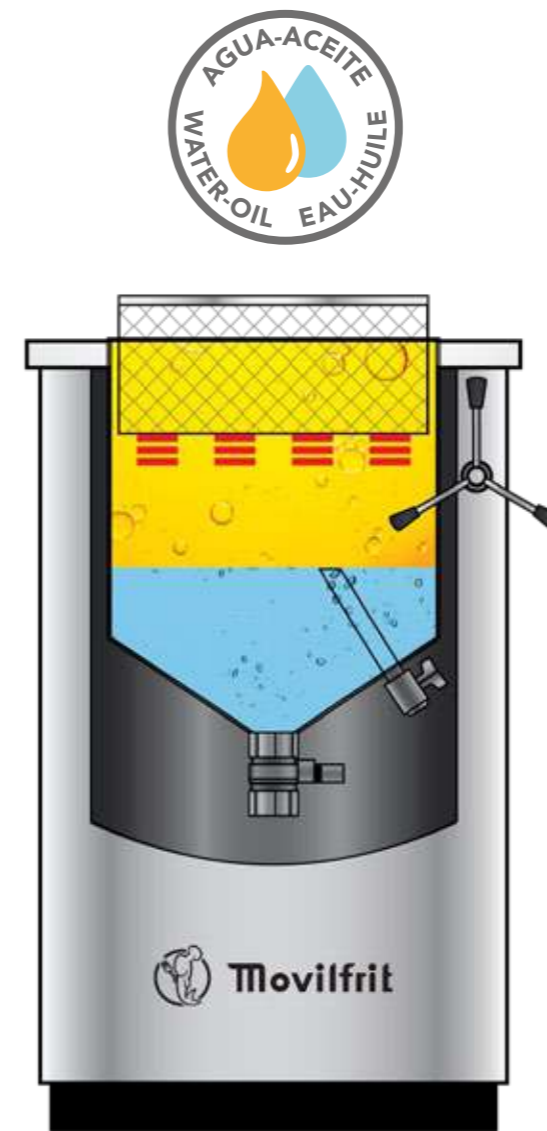
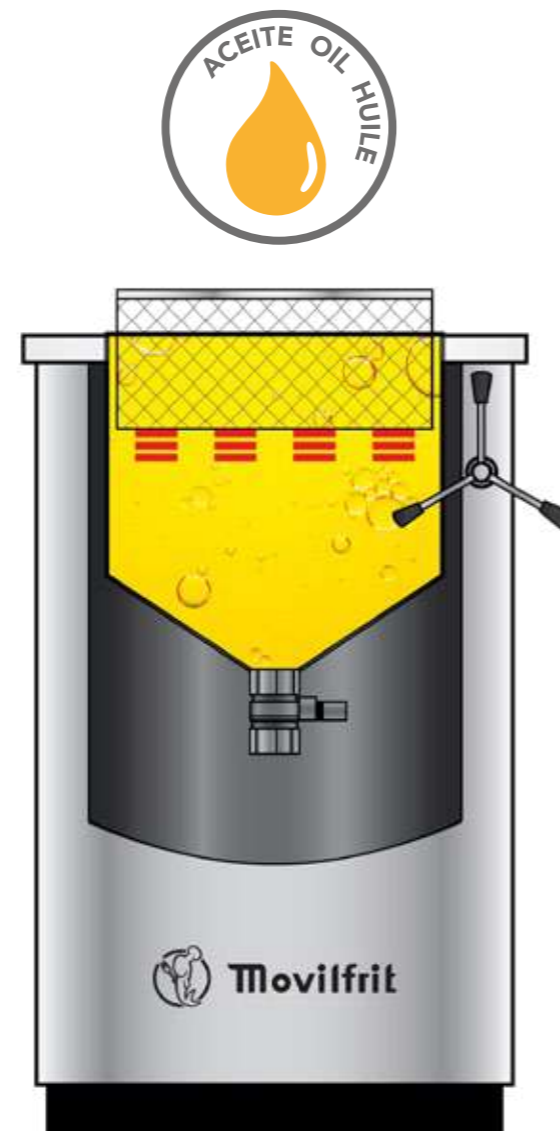



## MOBILE OR FIXED RESISTANCE

In a fryer the heat necessary for frying food is supplied by the resistance that heats the oil and this in turn, heats the food.

If we have a fryer with a fixed heating element, we find ourselves in the need to heat the entire volume of oil that we have above the resistance. The same happens with fryers a movable basket.

If we have a fryer with a mobile heating element, by being able to place the resistance at the desired height, we find the following advantages:

- **Energy saving:** we heat only the necessary volumen in each frying basket.
- **Greater speed:** with less power we have a quicker response, we heat a smaller volumen of oil and we achieve higher frying quality.
- **Longer oil life:** by not heating the entire volume of oil in each frying, it lasts longer.

## RÉSISTANCE MOBILE OU FIXE

Dans une friteuse, la chaleur nécessaire à la friture des aliments est fournie par la résistance que chauffe l'huile et celle-ci, à son tour, chauffe les aliments.

Si on a une friteuse avec un élément chauffant fixe, on se trouve dans la nécessité de chauffer tout le volume d'huile que on a au-dessus de la résistance. La même chose se produit avec les friteuses à panier mobile.

Si on a une friteuse avec un élément chauffant mobile, en pouvant placer la résistance à la hauteur souhaitée, on se trouve les avantages suivants :

- **Économie d'énergie :** N'on se chauffe que le volume nécessaire dans chaque panier de friture.
- **Plus grande vitesse :** avec moins de puissance, on a une réponse plus rapide, on chauffe un plus petit volume d'huile et on obtient une meilleure qualité de friture.
- **Durée de vie de l'huile plus longue :** en ne chauffant pas tout le volume d'huile à chaque friture, elle dure plus longtemps.

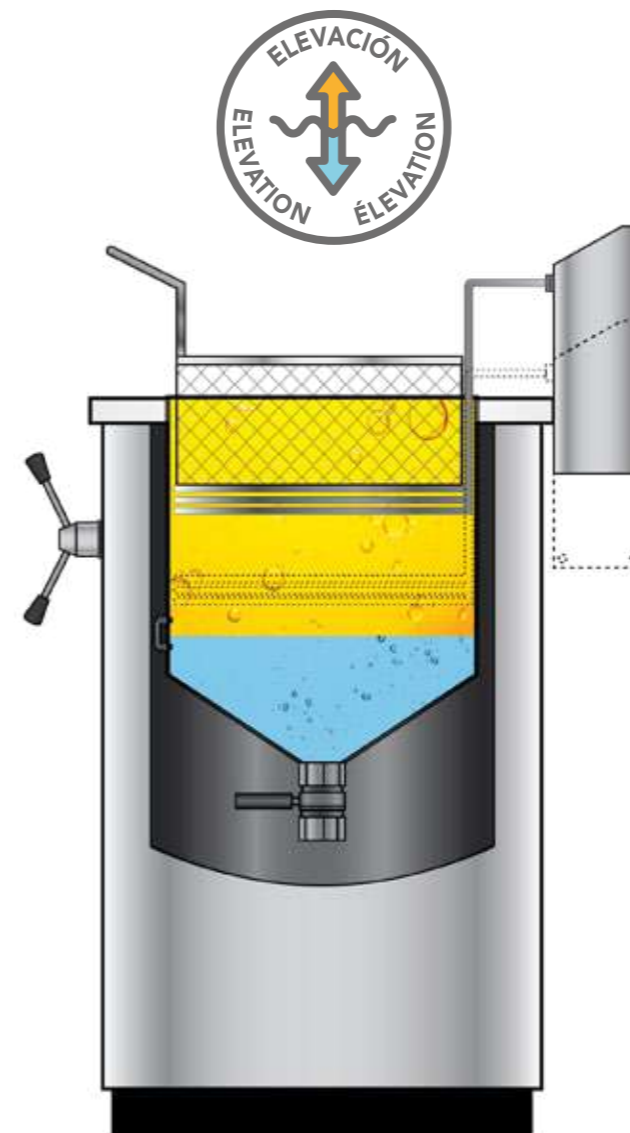

## RESISTENCIA MÓVIL O FIJA

En una freidora el calor necesario para la friture de los alimentos es suministrado por la resistencia que calienta el aceite y este a su vez al alimento.

Si disponemos de una freidora con elemento calefactor fijo, nos vemos en la necesidad de calentar todo el volumen de aceite que tenemos por encima de la resistencia. Igual ocurre con las freidoras con cesta móvil.

Si disponemos de una freidora con el elemento calefactor móvil, al poder situar la resistencia a la altura deseada, nos encontramos con las siguientes ventajas:

- **Ahorro de energía:** calentamos solamente el volumen necesario en cada cesta de friture.
- **Mayor rapidez:** con menor potencia tenemos una respuesta rápida, calentamos menor volumen de aceite y conseguimos mayor calidad de friture.
- **Mayor duración de aceite:** al no calentar en cada friture todo el volumen de aceite, este tiene mayor duración.

OIL QUALITY CONTROL SYSTEM

SYSTÈME DU CONTROL DE LA QUALITÉ DE L'HUILE



CALIDAD ACEITE (COMPONENTES POLARES)

OIL QUALITY (POLAR COMPONENTS)	
QUALITÉ DE L'HUILE (COMPOSANTS POLAIRES)	
REF.	€ x 1
640005	535



TIRAS CALIDAD ACEITE

OIL QUALITY STRIPS	
BANDES DE QUALITÉ D'HUILE	
REF.	€ x 50
640006	50



SISTEMA DE CONTROL DE LA CALIDAD DEL ACEITE



FILTRO DE ACEITE

OIL FILTER	
FILTRE D'HUILE	
REF.	€ x 1
640003	3636

CARTON PARA FILTRO DE ACEITE

CARTON FOR OIL FILTER	
CARTON POUR FILTRE À HUILE	
REF.	€ x 50
640004	261

NEW

CONTROL ACEITE



(+34) 936 358 758

(+34) 608 299 107

pedidos@movilfritofficial.com

www.movilfritofficial.com



**ECONOMIC ELECTRIC FRYERS**  
REMOVABLE HEAD

Built in AISI304 stainless steel

- (A) Removable electric head (easy cleaning)
- (B) Safety thermostat
- (C) General switch
- (D) Adjustable working thermostat
- (E) Non-slip legs
- (F) Tap to drain

**FRITEUSES ÉLECTRIQUES ÉCONOMIQUES**  
TÊTE AMOVABLE

Construit en acier inoxydable AISI304

- (A) Tête électrique amovible (nettoyage facile)
- (B) Thermostat de sécurité
- (C) Interrupteur général
- (D) Thermostat de travail réglable
- (E) Pieds antidérapants
- (F) Robinet à vidanger



FA 8

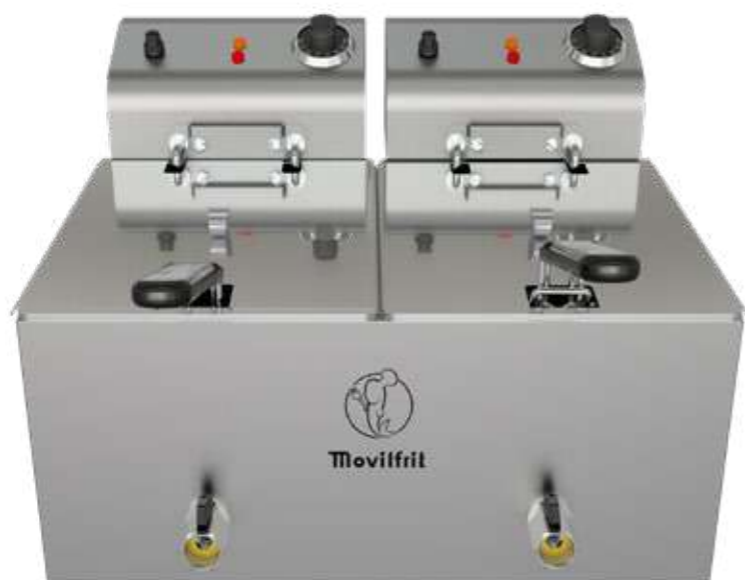

FA 10+10

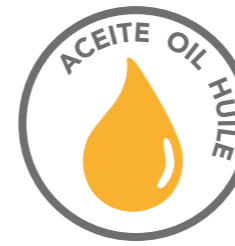

**FREIDORAS ELÉCTRICAS ECONÓMICAS**  
CABEZAL EXTRAÍBLE

Construida en acero inoxidable AISI304

- (A) Cabezal eléctrico extraíble (limpieza fácil)
- (B) Termostato seguridad
- (C) Interruptor general
- (D) Termostato trabajo regulable
- (E) Patas antideslizantes
- (F) Grifo de vaciado



FA 10+10 MAX 400

FA



- Aceite  
Oil  
Huile
- 230/400V
- 200°C
- Grifo  
Tap  
Robinet
- Personalizable  
Customisable  
Personnalisable

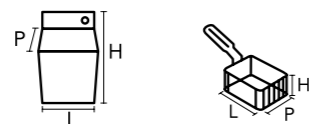

MOD.	kW	V	LxPxH (mm)	LxPxH (mm)	KG	REF.	€	REF.	€		
FA 4	2	230	4	180 x 425 x 282	120 x 240 x 85	4	157399	336	-		
FA 4+4	2+2		4+4	360 x 425 x 282		7	857398	640	-		
FA 6	3		6	265 x 420 x 335	210 x 235 x 95	6,5	157400	344	-		
FA 6+6	3+3		6+6	530 x 420 x 335		12	157401	650	-		
FA 8	4		8	265 x 420 x 335	210 x 235 x 110	7	157410	378	157506	394	
FA 8+8	4+4		8+8	530 x 420 x 335		12	157411	703	157507	739	
FA 10	4		9	265 x 420 x 335		7	157500	378	157412	394	
FA 10+10	4+4		9+9	530 x 420 x 335		12	157501	703	157413	739	
FA 8 MAX 230	6		230	8	265 x 420 x 335	210 x 235 x 110	8	157600	766	157620	793
FA 8+8 MAX 230	6+6			8+8	530 x 420 x 335		13	157601	1450	157621	1506
FA 8 MAX 400	6	400	9	265 x 420 x 335	8		157602	820	157622	847	
FA 8+8 MAX 400	6+6		9+9	530 x 420 x 335	13		157603	1557	157623	1613	
FA 10 MAX 230	6	230	9	265 x 420 x 335	8		157502	766	157414	793	
FA 10+10 MAX 230	6+6		9+9	530 x 420 x 335	13		157503	1450	157415	1506	
FA 10 MAX 400	9	400	9	265 x 420 x 335	9		157604	845	157624	927	
FA 10+10 MAX 400	9+9		9+9	530 x 420 x 335	15		157605	1582	157625	1760	

ACCESORIOS NO INCLUIDOS    ACCESORIES NOT INCLUDED    ACCESSOIRES NON INCLUS



MOD.	REF.	€ x 1	REF.	€ x 1
4	907039	100,15	-	-
6	907037	102,69	901101	35,02
8	907045	111,77	901100	40,10
10				

(+34) 936 358 758

(+34) 608 299 107

pedidos@movilfritofficial.com

www.movilfritofficial.com

**ECONOMIC ELECTRIC FRYERS**  
DOUBLE CONTACTOR  
REMOVABLE HEAD

Built in AISI304 stainless steel

- A** Removable electric head (easy cleaning)
- B** Safety thermostat
- D** Adjustable working thermostat
- E** Non-slip legs
- F** Tap to drain
- G** Double contactor

**FRITEUSES ÉLECTRIQUES ÉCONOMIQUES**  
DOUBLE CONTACTEUR  
TÊTE AMOVABLE

Construit en acier inoxydable AISI304

- A** Tête électrique amovible (nettoyage facile)
- B** Thermostat de sécurité
- D** Thermostat de travail réglable
- E** Pieds antidérapants
- F** Robinet à vidanger
- G** Double contacteur



**FREIDORAS ELÉCTRICAS ECONÓMICAS**  
DOBLE CONTACTOR  
CABEZAL EXTRAÍBLE

Construida en acero inoxidable AISI304

- A** Cabezal eléctrico extraíble (limpieza fácil)
- B** Termostato seguridad
- D** Termostato trabajo regulable
- E** Patas antideslizantes
- F** Grifo de vaciado
- G** Doble contactor

DC



DC 10 CON GRIFO



DC 8+8 SIN GRIFO



DC 8+8 CON GRIFO



- Aceite  
Oil  
Huile
- 230V
- 200°C
- Grifo  
Tap  
Robinet
- Personalizable  
Customisable  
Personnalisable

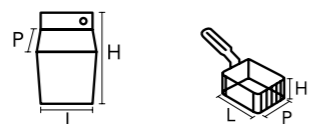

MOD.	kW	V		LxPxH (mm)	LxPxH (mm)	KG	REF.	€	REF.	€
DC 6	3	230	6	265 x 420 x 335	210 x 235 x 110	6,5	157380	<b>438</b>	-	
DC 6+6	3+3	230	6+6	530 x 420 x 335		12	157381	<b>847</b>	-	
DC 8	4	230	8	265 x 420 x 335		7	157382	<b>480</b>	157388	<b>535</b>
DC 8+8	4+4	230	8+8	530 x 420 x 335		12	157383	<b>884</b>	157389	<b>995</b>
DC 10	4	230	9	265 x 420 x 335		7	157386	<b>480</b>	157384	<b>535</b>
DC 10+10	4+4	230	9+9	530 x 420 x 335		12	157387	<b>884</b>	157385	<b>995</b>

ACCESORIOS NO INCLUIDOS

ACCESORIES NOT INCLUDED

ACCESSOIRES NON INCLUS



MOD.	Cesta reforzada Reinforced basket Panier renforcé		Filtro de residuos Residue filter Filtre à déchets	
	REF.	€ x 1	REF.	€ x 1
6	907037	<b>102,69</b>	901101	<b>35,02</b>
8	907045	<b>111,77</b>	901100	<b>40,10</b>
10				



**ECONOMIC ELECTRIC FRYERS**  
PREMIUM TANK  
REMOVABLE & FOLDING HEAD

Built in AISI304 stainless steel

- A** Removable electric head (easy cleaning)
- B** Safety thermostat
- C** General switch
- D** Adjustable working thermostat
- E** Non-slip legs
- F** Tap to drain
- G** V cube

**FRITEUSES ÉLECTRIQUES ÉCONOMIQUES**  
RÉSERVOIR PREMIUM  
TÊTE AMOVABLE ET ABATTABLE

Construit en acier inoxydable AISI304

- A** Tête électrique amovible (nettoyage facile)
- B** Thermostat de sécurité
- C** Interrupteur général
- D** Thermostat de travail réglable
- E** Pieds antidérapants
- F** Robinet à vidanger
- G** Cubette V

**NEW**

**PRO**

**FREIDORAS ELÉCTRICAS ECONÓMICAS**  
CUBA PREMIUM  
CABEZAL EXTRAÍBLE Y ABATIBLE

Construida en acero inoxidable AISI304

- A** Cabezal eléctrico extraíble (limpieza fácil)
- B** Termostato seguridad
- C** Interruptor general
- D** Termostato trabajo regulable
- E** Patas antideslizantes
- F** Grifo de vaciado
- G** Cuba en V



PRO MAX 10 400



PRO 8+8 230



PRO MAX 10+10 400



- Aceite  
Oil  
Huile
- 230/400V
- 200°C
- Grifo  
Tap  
Robinet
- Personalizable  
Customisable  
Personnalisable

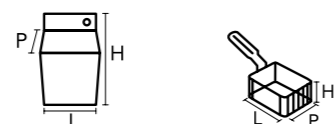

MOD.	kW	V		L x P x H (mm)	L x P x H (mm)	KG	REF.	€				
PRO 8 230	4	230		8	265 x 420 x 335	210 x 235 x 110	8	157800	<b>480</b>			
PRO 8+8 230	4+4			8+8	530 x 420 x 335		13	157801	<b>870</b>			
PRO DC 8 230	4			8	265 x 420 x 335		8	157804	<b>628</b>			
PRO DC 8+8 230	4+4			8+8	530 x 420 x 335		13	157805	<b>1173</b>			
PRO MAX 8 230	6			8	265 x 420 x 335		8	157808	<b>907</b>			
PRO MAX 8+8 230	6+6			8+8	530 x 420 x 335		13	157809	<b>1728</b>			
PRO MAX 8 400	6	400		8	265 x 420 x 335	210 x 235 x 110	8	157810	<b>966</b>			
PRO MAX 8+8 400	6+6			8+8	530 x 420 x 335		13	157811	<b>1845</b>			
PRO 10 230	4			230			9	265 x 420 x 335	210 x 235 x 110	8	157802	<b>480</b>
PRO 10+10 230	4+4						9+9	530 x 420 x 335		13	157803	<b>870</b>
PRO DC 10 230	4						9	265 x 420 x 335		8	157806	<b>628</b>
PRO DC 10+10 230	4+4						9+9	530 x 420 x 335		13	157807	<b>1173</b>
PRO MAX 10 230	6	9	265 x 420 x 335			8	157812	<b>907</b>				
PRO MAX 10+10 230	6+6	9+9	530 x 420 x 335			13	157813	<b>1728</b>				
PRO MAX 10 400	9	400		9	265 x 420 x 335	210 x 235 x 110	9	157814	<b>1053</b>			
PRO MAX 10+10 400	9+9			9+9	530 x 420 x 335		15	157815	<b>2004</b>			

ACCESORIOS NO INCLUIDOS

ACCESORIES NOT INCLUDED

ACCESSOIRES NON INCLUS



MOD.	REF.	€ x 1	REF.	€ x 1
8	907045	<b>111,77</b>	Cesta reforzada Reinforced basket Panier renforcé	Filtro de residuos Residue filter Filtre à déchets
10			901100	<b>40,10</b>

(+34) 936 358 758

(+34) 608 299 107

pedidos@movifritofficial.com

www.movifritofficial.com

**ECONOMIC ELECTRIC FRYERS TO COMBINE REMOVABLE HEAD**

Built in AISI304 stainless steel

- A** Removable electric head (easy cleaning)
- B** Safety thermostat
- D** Adjustable working thermostat
- E** Non-slip legs
- F** Tap to drain

**FRITEUSES ÉLECTRIQUES ÉCONOMIQUES À COMBINER TÊTE AMOVABLE**

Construit en acier inoxydable AISI304

- A** Tête électrique amovible (nettoyage facile)
- B** Thermostat de sécurité
- D** Thermostat de travail réglable
- E** Pieds antidérapants
- F** Robinet à vidanger



FA COM 10+10+10

Choose the power setting that best suits your needs, either in double or triple fryer.

Choisissez la puissance qui convient le mieux à vos besoins, que ce soit en double ou en triple friteuse.

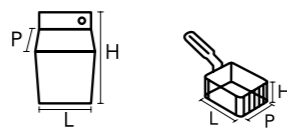

MOD.	kW	V	⚡	L x P x H (mm)	L x P x H (mm)	KG	REF.	€	REF.	€
FA-COM 10+10	4+6	230+400	10 (x2)	530x420x335	210x235x110	12,5	158100	<b>1116</b>	158300	<b>1167</b>
	4+9	230+400					158101	<b>1139</b>	158301	<b>1242</b>
	6+9	400+400					158102	<b>1565</b>	158302	<b>1668</b>
FA-COM 10+10+10	4+4+4	230+230+230	10 (x3)	795x420x335	210x235x110 (x3)	24	158500	<b>1035</b>	158700	<b>1111</b>
	4+4+6	230+230+400					158501	<b>1461</b>	158701	<b>1537</b>
	4+6+6	230+400+400					158502	<b>1887</b>	158702	<b>1963</b>
	4+4+9	230+230+400					158503	<b>1484</b>	158703	<b>1612</b>
	4+9+9	230+400+400					158504	<b>1934</b>	158704	<b>2113</b>
	6+6+6	400+400+400					158505	<b>2312</b>	158705	<b>2389</b>
	6+6+9	400+400+400					158506	<b>2336</b>	158706	<b>2464</b>
	6+9+9	400+400+400					158507	<b>2359</b>	158707	<b>2539</b>
	4+6+9	400+400+400					158508	<b>1910</b>	158708	<b>2038</b>
9+9+9	400+400+400	158509	<b>2383</b>	158709	<b>2614</b>					



**FREIDORAS ELÉCTRICAS ECONÓMICAS A COMBINAR CABEZAL EXTRAÍBLE**

Construida en acero inoxidable AISI304

- A** Cabezal eléctrico extraíble (limpieza fácil)
- B** Termostato seguridad
- D** Termostato trabajo regulable
- E** Patas antideslizantes
- F** Grifo de vaciado



FA COM 10+10

Elija la configuración de potencia que mejor se adapte a sus necesidades, ya sea en doble o triple freidora.

**NEW**

**FA COM**

- Aceite  
Oil  
Huile
- 230/400V
- 200°C
- Grifo  
Tap  
Robinet
- Personalizable  
Customisable  
Personnalisable

ACCESORIOS NO INCLUIDOS    ACCESORIES NOT INCLUDED    ACCESSOIRES NON INCLUS



MOD.	REF.	€ x 1	REF.	€ x 1
4	907039	<b>100,15</b>	-	-
6	907037	<b>102,69</b>	901101	<b>35,02</b>
8	907045	<b>111,77</b>	901100	<b>40,10</b>
10				

(+34) 936 358 758

(+34) 608 299 107

pedidos@movifritofficial.com

www.movifritofficial.com



**ECONOMIC ELECTRIC FRYERS**  
REMOVABLE HEAD

Built in AISI304 stainless steel

- A** Removable electric head (easy cleaning)
- C** General switch
- D** Adjustable working thermostat
- E** Non-slip legs
- F** Tap to drain

**FRITEUSES ÉLECTRIQUES ÉCONOMIQUES**  
TÊTE AMOVABLE

Construit en acier inoxydable AISI304

- A** Tête électrique amovible (nettoyage facile)
- C** Interrupteur général
- D** Thermostat de travail réglable
- E** Pieds antidérapants
- F** Robinet à vidanger

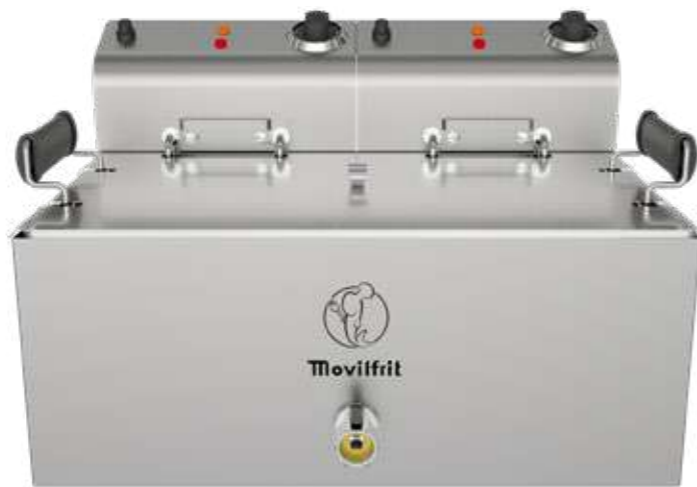



FA 20 230

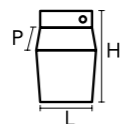

FA 30 400



MOD.	kW	V			L x P x H (mm)	L x P x H (mm)	KG	REF.	€
FA 20 230	4+4	230	20		530 x 430 x 335	470 x 250 x 110	14	157509	1750
FA 16 400	9	400	16		530 x 460 x 370	250 x 470 x 110	14	157510	1250
FA 30 400	15	400	30		650 x 670 x 370	575 x 445 x 110	20	157511	2050

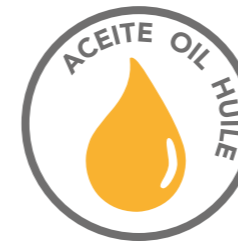

**FREIDORAS ELÉCTRICAS ECONÓMICAS**  
CABEZAL EXTRAÍBLE

Construida en acero inoxidable AISI304

- A** Cabezal eléctrico extraíble (limpieza fácil)
- C** Interruptor general
- D** Termostato trabajo regulable
- E** Patas antideslizantes
- F** Grifo de vaciado



FA 16 400

-  Aceite  
Oil  
Huile
-  230/400V
-  200°C
-  Grifo  
Tap  
Robinet
-  Personalizable  
Customisable  
Personnalisable

**NEW**

**FA**  
**CACHOPO**



 (+34) 936 358 758

 (+34) 608 299 107

 pedidos@movifritofficial.com

www.movifritofficial.com

ELECTRIC FRYERS  
REMOVABLE HEAD

Built in AISI304 stainless steel

- (A) Removable electric head (easy cleaning)
- (B) Safety thermostat
- (C) General switch
- (D) Adjustable working thermostat
- (E) Non-slip legs
- (F) Tap to drain

FRITEUSES ÉLECTRIQUES  
TÊTE AMOVABLE

Construit en acier inoxydable AISI304

- (A) Tête électrique amovible (nettoyage facile)
- (B) Thermostat de sécurité
- (C) Interrupteur général
- (D) Thermostat de travail réglable
- (E) Pieds antidérapants
- (F) Robinet à vidanger



FAP 10



FAP 12+12 400



FAP 17 400

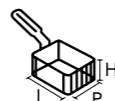
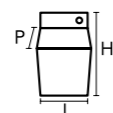

MOD.	kW	V	Icon	L x P x H (mm)	L x P x H (mm)	KG	REF.	€		
FAP 10	4	230	Icon	10	325 x 510 x 450	14	157407	834		
FAP 10+10	4+4			10+10	650 x 510 x 450	27	157409	1604		
FAP 10 MAX 230	6			10	325 x 510 x 450	18	157424	1362		
FAP 10+10 MAX 230	6+6	400	Icon	10+10	650 x 510 x 450	34	157425	2660		
FAP 10 MAX 400	6			10	325 x 510 x 450	18	157426	1416		
FAP 10+10 MAX 400	6+6			10+10	650 x 510 x 450	34	157427	2767		
FAP 12 230	6	230	Icon	12	360 x 645 x 450	27	157430	1536		
FAP 12+12 230	6+6			12+12	720 x 645 x 450	51	157431	3009		
FAP 12 400	7			12	360 x 645 x 450	27	157432	1556		
FAP 12+12 400	7+7	400	Icon	12+12	720 x 645 x 450	51	157433	3040		
FAP 17 230	6			230	Icon	17	360 x 645 x 940	28	157418	1777
FAP 17+17 230	6+6					17+17	720 x 645 x 940	51	157419	3366
FAP 17 400	7	17	360 x 645 x 940			28	157420	1832		
FAP 17+17 400	7+7	400	Icon	17+17	720 x 645 x 940	51	157423	3482		
FAP 25 400	15			25	410 x 645 x 940	38	157434	2388		
FAP 25+25 400	15+15			25+25	820 x 645 x 940	71	157435	4624		
FAP 35 400	25	400	Icon	35	530 x 645 x 940	44	157436	3138		
FAP 35+35 400	25+25			35+35	1065 x 645 x 940	86	157437	5727		



FREIDORAS ELÉCTRICAS  
CABEZAL EXTRAÍBLE

Construida en acero inoxidable AISI304

- (A) Cabezal eléctrico extraíble (limpieza fácil)
- (B) Termostato seguridad
- (C) Interruptor general
- (D) Termostato trabajo regulable
- (E) Patas antideslizantes
- (F) Grifo de vaciado



FAP 25+25 400

FAP

- Aceite  
Oil  
Huile
- 230/400V
- 200°C
- Grifo  
Tap  
Robinet
- Personalizable  
Customisable  
Personnalisable

ACCESORIOS NO INCLUIDOS			ACCESORIES NOT INCLUDED			ACCESSOIRES NON INCLUS		
Cesta partida Double basket Panier double	Filtro de residuos Residue filter Filtre à déchets	Cajón de vaciado Drain tank Bac de vidange	Basket fixing bracket Support fixation du panier					
MOD.	REF.	€ x 1	REF.	€ x 1	REF.	€ x 1	REF.	€ x 1
10	-		901102	45,28	-			
12	907052	125,15	901103	50,31	-			
17	907052	125,15	901103	50,31			905417	92,00
25	907033	143,20	901104	55,63	905416	392,00		
35	907034	254,76	901105	60,12				



ELECTRIC FRYERS  
REMOVABLE HEAD WITH ELEVATION

Built in AISI304 stainless steel

- (A) Removable electric head (easy cleaning)
- (B) Safety thermostat
- (C) General switch
- (D) Adjustable working thermostat
- (E) Non-slip legs
- (F) Tap to drain
- (H) Elevation system

FRITEUSES ÉLECTRIQUES  
TÊTE AMOVABLE AVEC ÉLÉVATION

Construit en acier inoxydable AISI304

- (A) Tête électrique amovible (nettoyage facile)
- (B) Thermostat de sécurité
- (C) Interrupteur général
- (D) Thermostat de travail réglable
- (E) Pieds antidérapants
- (F) Robinet à vidanger
- (H) Système d'élévation



FAH 10 400



FAH 12+12 400

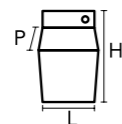

FAH 25 400

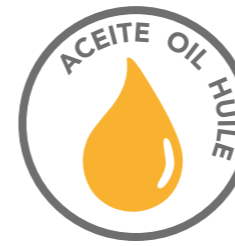

FREIDORAS ELÉCTRICAS  
CABEZAL EXTRAÍBLE CON ELEVACIÓN

Construida en acero inoxidable AISI304

- (A) Cabezal eléctrico extraíble (limpieza fácil)
- (B) Termostato seguridad
- (C) Interruptor general
- (D) Termostato trabajo regulable
- (E) Patas antideslizantes
- (F) Grifo de vaciado
- (H) Sistema de elevación



FAH 17+17 400

FAH



- Aceite  
Oil  
Huile
- 230/400V
- 200°C
- Grifo  
Tap  
Robinet
- Elevación  
Elevation  
Élévation
- Personalizable  
Customisable  
Personnalisable

MOD.	kW	V		L x P x H (mm)	L x P x H (mm)	KG	REF.	€	
FAH 10	4	230	10	325 x 600 x 450	185 x 245 x 110	14	157356	1410	
FAH 10+10	4+4	230	10+10	650 x 600 x 450		27	157358	2786	
FAH 10 400	6	400	10	325 x 600 x 450		18	157357	1466	
FAH 10+10 400	6+6	400	10+10	650 x 600 x 450		34	157359	2899	
FAH 12 230	6	230	12	360 x 645 x 450	205 x 285 x 120	27	157340	1599	
FAH 12+12 230	6+6	230	12+12	720 x 645 x 450		51	157341	3166	
FAH 12 400	7	400	12	360 x 645 x 450		27	157342	1665	
FAH 12+12 400	7+7	400	12+12	720 x 645 x 450		51	157343	3297	
FAH 17 230	6	230	17	360 x 645 x 940		235 x 325 x 140	28	157360	1840
FAH 17+17 230	6+6	230	17+17	720 x 645 x 940			51	157362	3557
FAH 17 400	7	400	17	360 x 645 x 940	28		157361	1895	
FAH 17+17 400	7+7	400	17+17	720 x 645 x 940	51		157363	3672	
FAH 25 400	15	400	25	410 x 645 x 940	350 x 325 x 150	38	157365	2462	
FAH 25+25 400	15+15	400	25+25	820 x 645 x 940		71	157367	4795	
FAH 35 400	25	400	35	530 x 645 x 940		44	157368	3217	
FAH 35+35 400	25+25	400	35+35	1065 x 645 x 940	86	157370	5946		

ACCESORIOS NO INCLUIDOS			ACCESSORIES NOT INCLUDED			ACCESSOIRES NON INCLUS		
Cesta partida Double basket Panier double	Filtro de residuos Residue filter Filtre à déchets	Cajón de vaciado Drain tank Bac de vidange	Soporte fijación cesta Basket fixing bracket Support fixation du panier					
MOD.	REF.	€ x 1	REF.	€ x 1	REF.	€ x 1	REF.	€ x 1
10	-		901102	45,28	-			
12	907052	125,15	901103	50,31	-			
17	907052	125,15	901103	50,31			905417	92,00
25	907033	143,20	901104	55,63	905416	392,00		
35	907034	254,76	901105	60,12				

**ELECTRIC FRYERS**  
HIGH POWER  
REMOVABLE HEAD WITH/WITHOUT ELEVATION

Built in AISI304 stainless steel

- (A) Removable electric head (easy cleaning)
- (B) Safety thermostat
- (C) General switch
- (D) Adjustable working thermostat
- (E) Non-slip legs
- (F) Tap to drain
- (H) Elevation system

**FRITEUSES ÉLECTRIQUES**  
HAUTE PUISSANCE  
TÊTE AMOVABLE AVEC/SANS ÉLÉVATION

Construit en acier inoxydable AISI304

- (A) Tête électrique amovible (nettoyage facile)
- (B) Thermostat de sécurité
- (C) Interrupteur général
- (D) Thermostat de travail réglable
- (E) Pieds antidérapants
- (F) Robinet à vidanger
- (H) Système d'élévation



FAR 10 400



FAR 10+10 400



FAR 25 400

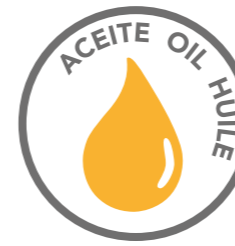
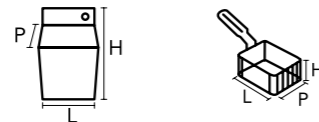

**FREIDORAS ELÉCTRICAS**  
ALTO RENDIMIENTO  
CABEZAL EXTRAÍBLE SIN/CON ELEVACIÓN

Construida en acero inoxidable AISI304

- (A) Cabezal eléctrico extraíble (limpieza fácil)
- (B) Termostato seguridad
- (C) Interruptor general
- (D) Termostato trabajo regulable
- (E) Patas antideslizantes
- (F) Grifo de vaciado
- (H) Sistema de elevación



FAR 17+17 400

**FARP  
FAR**

- Aceite  
Oil  
Huile
- 400V
- 200°C
- Grifo  
Tap  
Robinet
- Elevación  
Elevation  
Élévation
- Personalizable  
Customisable  
Personnalisable

MOD.	kW	V	LxPxH (mm)	LxPxH (mm)	KG	REF.	€	
FAR 10 400	10	400	325 x 510 x 450	185 x 245 x 110	18	-	157326	1904
FAR 10+10 400	10+10		650 x 510 x 450		34	-	157327	3563
FAR 12 400	12		360 x 645 x 450		27	-	157332	1982
FAR 12+12 400	12+12		720 x 645 x 450	205 x 285 x 120	51	-	157333	3807
FAR 17 400	17		360 x 645 x 940		28	-	157328	2424
FAR 17+17 400	17+17		720 x 645 x 940		51	-	157329	4534
FAR 25 400	25		410 x 645 x 940	235 x 325 x 140	38	-	157330	3240
FAR 25+25 400	25+25		820 x 645 x 940		71	-	157331	6261
FAR 10 400	10		325 x 510 x 450		18	✓	157320	1970
FAR 10+10 400	10+10		650 x 510 x 450	34	✓	157319	3686	
FAR 12 400	12		360 x 645 x 450	27	✓	157317	2119	
FAR 12+12 400	12+12		720 x 645 x 450	51	✓	157318	4050	
FAR 17 400	17		360 x 645 x 940	28	✓	157321	2507	
FAR 17+17 400	17+17		720 x 645 x 940	51	✓	157322	4690	
FAR 25 400	25		410 x 645 x 940	38	✓	157324	3353	
FAR 25+25 400	25+25	820 x 645 x 940	71	✓	157325	6478		

ACCESORIOS NO INCLUIDOS			ACCESORIES NOT INCLUDED			ACCESSOIRES NON INCLUS		
Cesta partida Double basket Panier double	Filtro de residuos Residue filter Filtre à déchets	Cajón de vaciado Drain tank Bac de vidange	Soporte fijación cesta Basket fixing bracket Support de fixation du panier					
MOD.	REF.	€ x 1	REF.	€ x 1	REF.	€ x 1	REF.	€ x 1
10	-		901102	45,28	-		-	
12	907052	125,15	901103	50,31	-		-	
17	907052	125,15	901103	50,31	-		905417	92,00
25	907033	143,20	901104	55,63	905416	392,00	-	
35	-		-		-		-	



**ELECTRIC FRYERS**  
REMOVABLE HEAD WITH/WITHOUT ELEVATION

Built in AISI304 stainless steel

- (A) Removable electric head (easy cleaning)
- (B) Safety thermostat
- (C) General switch
- (D) Adjustable working thermostat
- (E) Non-slip legs
- (F) Tap to drain
- (H) Elevation system

**FRITEUSES ÉLECTRIQUES**  
TÊTE AMOVABLE AVEC/SANS ÉLÉVATION

Construit en acier inoxydable AISI304

- (A) Tête électrique amovible (nettoyage facile)
- (B) Thermostat de sécurité
- (C) Interrupteur général
- (D) Thermostat de travail réglable
- (E) Pieds antidérapants
- (F) Robinet à vidanger
- (H) Système d'élévation



FAP 10+10+10 230



FAH 12+12+12 400

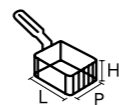
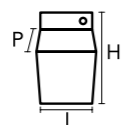

MOD.	kW	V			L x P x H (mm)	L x P x H (mm)			REF.	€
FAP 10+10+10 230	4 (x3)	230			975 x 510 x 475		-	42	156200	2165
FAP 10+10+10 MAX 230	6 (x3)	230		10 (x3)	975 x 600 x 450	185 x 245 x 110	-	54	156220	3686
FAP 10+10+10 MAX 400	6 (x3)	400			975 x 600 x 450		-	54	156221	3841
FAP 12+12+12 230	6 (x3)	230		12 (x3)	1080 x 580 x 450		-	81	156340	4189
FAP 12+12+12 400	7 (x3)	400			1080 x 580 x 450	205 x 285 x 120	-	81	156341	4240
FAP 17+17+17 230	6 (x3)	230		17 (x3)	1080 x 645 x 940		-	153	156450	4766
FAP 17+17+17 400	7 (x3)	400			1080 x 645 x 940		-	153	156451	4935
FAH 10+10+10 230	6 (x3)	230		10 (x3)	975 x 600 x 450	185 x 245 x 110	✓	54	156250	3854
FAH 10+10+10 400	6 (x3)	400			975 x 600 x 450		✓	54	156251	4017
FAH 12+12+12 230	6 (x3)	230		12 (x3)	1080 x 580 x 450		✓	81	156330	4402
FAH 12+12+12 400	7 (x3)	400			1080 x 580 x 450	205 x 285 x 120	✓	81	156331	4590
FAH 17+17+17 230	6 (x3)	230		17 (x3)	1080 x 645 x 940		✓	153	156430	5072
FAH 17+17+17 400	7 (x3)	400			1080 x 645 x 940		✓	153	156431	5239

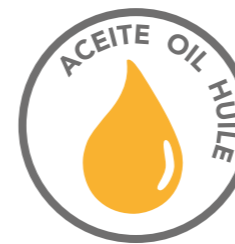

**FREIDORAS ELÉCTRICAS**  
CABEZAL EXTRAÍBLE SIN/CON ELEVACIÓN

Construida en acero inoxidable AISI304

- (A) Cabezal eléctrico extraíble (limpieza fácil)
- (B) Termostato seguridad
- (C) Interruptor general
- (D) Termostato trabajo regulable
- (E) Patas antideslizantes
- (F) Grifo de vaciado
- (H) Sistema de elevación



FAH 17+17+17 400

**TRIPLE**  
**FAP**  
**FAH**

- Aceite  
Oil  
Huile
- 230/400V
- 200°C
- Grifo  
Tap  
Robinet
- Elevación  
Elevation  
Élévation
- Personalizable  
Customisable  
Personnalisable

ACCESORIOS NO INCLUIDOS			ACCESORIES NOT INCLUDED			ACCESSOIRES NON INCLUS		
Cesta partida Double basket Panier double	Filtro de residuos Residue filter Filtre à déchets	Cajón de vaciado Drain tank Bac de vidange	Soporte fijación cesta Basket fixing bracket Support de fixation du panier					
MOD.	REF.	€ x 1	REF.	€ x 1	REF.	€ x 1	REF.	€ x 1
10	-		901102	45,28	-		-	
12	907052	125,15	901103	50,31	-		-	
17	907052	125,15	901103	50,31	-		-	
25	-		-		905416	392,00	905417	92,00
35	-		-					

(+34) 936 358 758

(+34) 608 299 107

pedidos@movifritofficial.com

www.movifritofficial.com

**ECONOMIC ELECTRIC FRYERS**  
REMOVABLE HEAD WITH/WITHOUT ELEVATION

Built in AISI304 stainless steel

- A** Removable electric head (easy cleaning)
- B** Safety thermostat
- D** Adjustable working thermostat
- E** Non-slip legs
- F** Tap to drain
- H** Elevation system
- I** Oil-water sight glass



FP 10 230

**FRITEUSES ÉLECTRIQUES ÉCONOMIQUES**  
TÊTE AMOVABLE AVEC/SANS ÉLÉVATION

Construit en acier inoxydable AISI304

- A** Tête électrique amovible (nettoyage facile)
- B** Thermostat de sécurité
- D** Thermostat de travail réglable
- E** Pieds antidérapants
- F** Robinet à vidanger
- H** Système d'élévation
- I** Voyant huile-eau



FP 10+10 230



**FREIDORAS ELÉCTRICAS ECONÓMICAS**  
CABEZAL EXTRAÍBLE SIN/CON ELEVACIÓN

Construida en acero inoxidable AISI304

- A** Cabezal eléctrico extraíble (limpieza fácil)
- B** Termostato seguridad
- D** Termostato trabajo regulable
- E** Patas antideslizantes
- F** Grifo de vaciado
- H** Sistema de elevación
- I** Visor agua-aceite



F 10+10 230

FP  
F

- Agua-Aceite  
Water-Oil  
Eau-Huile
- 230V
- 200°C
- Grifo  
Tap  
Robinet
- Visor  
Sight Glass  
Voyant
- Elevación  
Elevation  
Élévation
- Personalizable  
Customisable  
Personnalisable

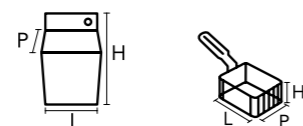

MOD.	kW	V			Total	L x P x H (mm)	L x P x H (mm)		KG	REF.	€
FP 10 230	4	230	3,5	10	13,5	325 x 510 x 475	185 x 245 x 110	-	14	107070	<b>957</b>
FP 10+10 230	4+4		3,5 (x2)	10 (x2)	13,5 (x2)	650 x 510 x 475		-	27	107071	<b>1840</b>
F 10 230	4		3,5	10	13,5	325 x 510 x 475		✓	14	107066	<b>1003</b>
F 10+10 230	4+4		3,5 (x2)	10 (x2)	13,5 (x2)	650 x 510 x 475		✓	27	107067	<b>1982</b>

ACCESORIOS NO INCLUIDOS

ACCESORIES NOT INCLUDED

ACCESSOIRES NON INCLUS



Filtro de residuos  
Residue filter  
Filtre à déchets



Soporte fijación cesta  
Basket fixing bracket  
Support de fixation du panier

MOD.	REF.	€ x 1	REF.	€ x 1
10	901102	<b>45,28</b>		
12	-			
17	-		905417	<b>92,00</b>
25	-			
35	-			



ELECTRIC FRYERS  
REMOVABLE HEAD WITH ELEVATION

Built in AISI304 stainless steel

- (A) Removable electric head (easy cleaning)
- (B) Safety thermostat
- (C) General switch
- (D) Adjustable working thermostat
- (E) Non-slip legs
- (F) Tap to drain
- (H) Elevation system
- (I) Oil-water sight glass

FRITEUSES ÉLECTRIQUES  
TÊTE AMOVABLE AVEC ÉLÉVATION

Construit en acier inoxydable AISI304

- (A) Tête électrique amovible (nettoyage facile)
- (B) Thermostat de sécurité
- (C) Interrupteur général
- (D) Thermostat de travail réglable
- (E) Pieds antidérapants
- (F) Robinet à vidanger
- (H) Système d'élévation
- (I) Voyant huile-eau



FREIDORAS ELÉCTRICAS  
CABEZAL EXTRAÍBLE CON ELEVACIÓN

Construida en acero inoxidable AISI304

- (A) Cabezal eléctrico extraíble (limpieza fácil)
- (B) Termostato seguridad
- (C) Interruptor general
- (D) Termostato trabajo regulable
- (E) Patas antideslizantes
- (F) Grifo de vaciado
- (H) Sistema de elevación
- (I) Visor agua/aceite



FH 10 230



FH 17+17 230



FH 25 400

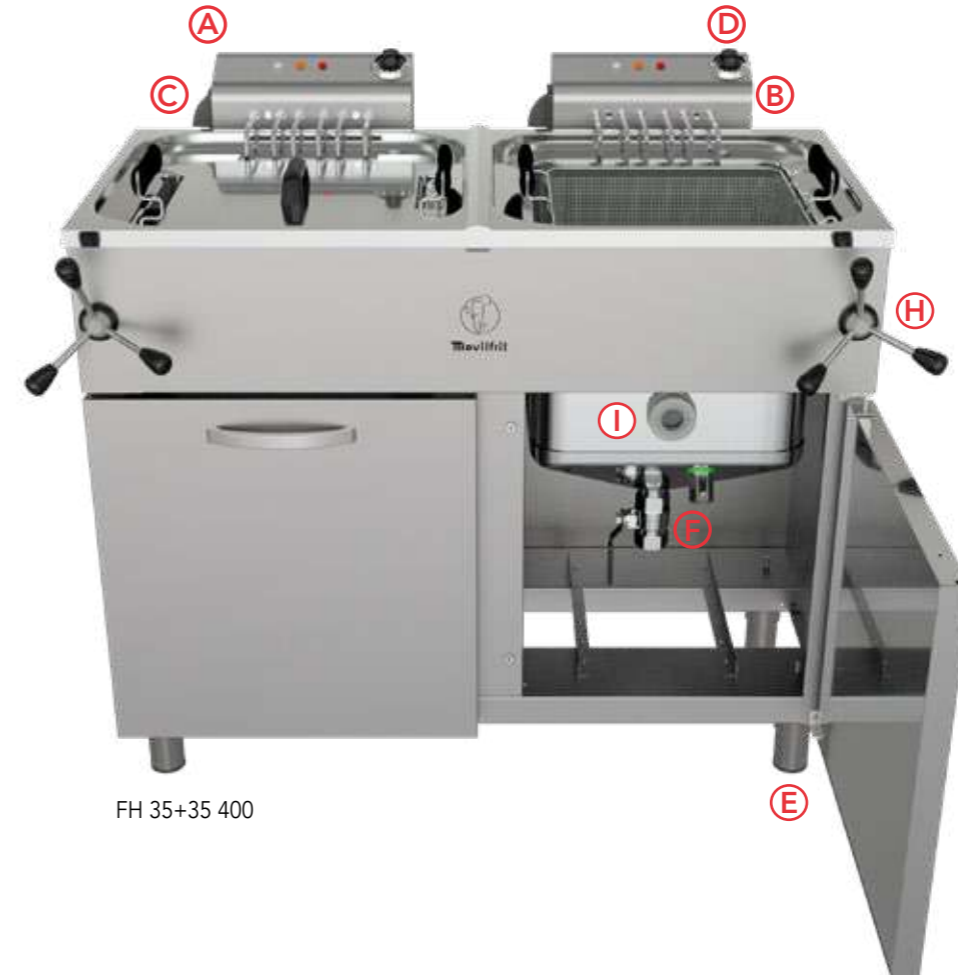

FH 35+35 400

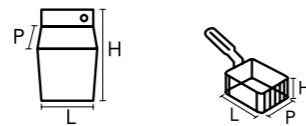

MOD.	kW	V				Total	L x P x H (mm)	L x P x H (mm)	KG	REF.	€
FH 10 230	6	230				13,5	325 x 510 x 450		18	107306	1453
FH 10+10 230	6+6	230				13,5 (x2)	650 x 510 x 450		34	107308	2843
FH 10 400	6	400				13,5	325 x 510 x 450	185 x 245 x 110	18	107307	1514
FH 10+10 400	6+6	400				13,5 (x2)	650 x 510 x 450		34	107309	2964
FH 17 230	6	230				19,5	360 x 645 x 940		28	107310	1866
FH 17+17 230	6+6	230				19,5 (x2)	720 x 645 x 940		51	107312	3552
FH 17 400	7	400				19,5	360 x 645 x 940	205 x 285 x 120	28	107311	1939
FH 17+17 400	7+7	400				19,5 (x2)	720 x 645 x 940		51	107313	3680
FH 25 400	15	400				31	410 x 645 x 940		38	107315	2677
FH 25+25 400	15+15	400				31 (x2)	820 x 645 x 940	235 x 325 x 140	71	107317	5056
FH 35 400	25	400				44	530 x 645 x 940		44	107318	3262
FH 35+35 400	25+25	400				44 (x2)	1065 x 645 x 940	350 x 325 x 150	86	107320	6037

ACCESORIOS NO INCLUIDOS			ACCESORIES NOT INCLUDED			ACCESSOIRES NON INCLUS		
Cesta partida Double basket Panier double	Filtro de residuos Residue filter Filtre à déchets	Cajón de vaciado Drain tank Bac de vidange	Soporte fijación cesta Basket fixing bracket Support de fixation du panier					
MOD.	REF.	€ x 1	REF.	€ x 1	REF.	€ x 1	REF.	€ x 1
10	-		901102	45,28	-		-	
12	907052	125,15	901103	50,31	-		-	
17	907052	125,15	901103	50,31	-		905417	92,00
25	907033	143,20	901104	55,63	905416	392,00		
35	907034	254,76	901105	60,12				

FH

- Agua-Aceite  
Water-Oil  
Eau-Huile
- 230/400V
- 200°C
- Grifo  
Tap  
Robinet
- Visor  
Sight Glass  
Voyant
- Elevación  
Elevation  
Élévation
- Personalizable  
Customisable  
Personnalisable

ELECTRIC FRYERS  
REMOVABLE HEAD WITH/WITHOUT ELEVATION

- Built in AISI304 stainless steel
- (A) Removable electric head (easy cleaning)
- (B) Safety thermostat
- (C) General switch
- (D) Adjustable working thermostat
- (E) Non-slip legs
- (F) Tap to drain
- (H) Elevation system
- (I) Oil-water sight glass

FRITEUSES ÉLECTRIQUES  
TÊTE AMOVABLE AVEC/SANS ÉLÉVATION

- Construit en acier inoxydable AISI304
- (A) Tête électrique amovible (nettoyage facile)
- (B) Thermostat de sécurité
- (C) Interrupteur général
- (D) Thermostat de travail réglable
- (E) Pieds antidérapants
- (F) Robinet à vidanger
- (H) Système d'élevation
- (I) Voyant huile-eau



FH 10+10+10 400



FP 10+10+10 230

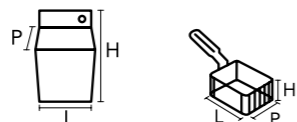

MOD.	kW	V			Total	L x P x H (mm)	L x P x H (mm)		KG	REF.	€
FP 10+10+10 230	4 (x3)	230	3,5 (x3)	10 (x3)	13,5 (x3)	975 x 510 x 475	185 x 245 x 110	-	40	108080	2590
F 10+10+10 230								✓	40	108100	2850
FH 10+10+10 230	6 (x3)	230	3,5 (x3)	10 (x3)	13,5 (x3)	975 x 600 x 450	185 x 245 x 110	✓	54	108200	4093
FH 10+10+10 400								✓	54	108201	4351
FH 17+17+17 230	6 (x3)	230	4,5 (x3)	15 (x3)	19,5 (x3)	1080 x 645 x 940		✓	80	108400	5087
FH 17+17+17 400								✓	80	108401	5262



FREIDORAS ELÉCTRICAS  
CABEZAL EXTRAÍBLE SIN/CON ELEVACIÓN

- Construida en acero inoxidable AISI304
- (A) Cabezal eléctrico extraíble (limpieza fácil)
- (B) Termostato seguridad
- (C) Interruptor general
- (D) Termostato trabajo regulable
- (E) Patas antideslizantes
- (F) Grifo de vaciado
- (H) Sistema de elevación
- (I) Visor agua/aceite



FH 17+17+17 230

TRIPLE  
FP  
F  
FH

- Agua-Aceite  
Water-Oil  
Eau-Huile
- 230/400V
- 200°C
- Grifo  
Tap  
Robinet
- Visor  
Sight Glass  
Voyant
- Elevación  
Elevation  
Élévation
- Personalizable  
Customisable  
Personnalisable

ACCESORIOS NO INCLUIDOS

ACCESORIES NOT INCLUDED

ACCESSOIRES NON INCLUS



MOD.	REF.	€ x 1	REF.	€ x 1	REF.	€ x 1	REF.	€ x 1
	Cesta partida Double basket Panier double		Filtro de residuos Residue filter Filtre à déchets		Cajón de vaciado Drain tank Bac de vidange		Soporte fijación cesta Basket fixing bracket Support de fixation du panier	
10	-		901102	45,28	-		-	
12	-		-		-		-	
17	907052	125,15	901103	50,31	-		905417	92,00
25	-		-		905416	392,00	-	
35	-		-		-		-	

(+34) 936 358 758

(+34) 608 299 107

pedidos@movifritofficial.com

www.movifritofficial.com



**GAS FRYERS**  
EXTERNAL BURNERS

Built in AISI304 stainless steel

- B** Adjustable working thermostat
- D** Safety thermostat
- E** Non-slip legs
- F** Tap to drain
- G** Embedded bowl without welding

**FRITEUSES À GAZ**  
BRÛLEURS EXTERNES

Construit en acier inoxydable AISI304

- B** Thermostat de sécurité
- D** Thermostat de travail réglable
- E** Pieds antidérapants
- F** Robinet à vidanger
- G** Bol encastrable sans soudure



FGS 8



FGS 10 MAX

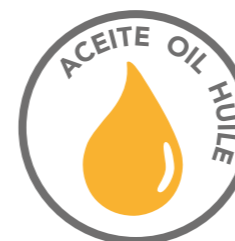

**FREIDORAS DE GAS**  
QUEMADORES EXTERNOS

Construida en acero inoxidable AISI304

- B** Termostato de seguridad
- D** Termostato trabajo regulable
- E** Patas antideslizantes
- F** Grifo de vaciado
- G** Cubeta embutida sin soldaduras



FGS 10+10 MAX

**FGS**

- Aceite  
Oil  
Huile
- Gas  
Gas  
Gaz
- 190°C
- Grifo  
Tap  
Robinet
- Personalizable  
Customisable  
Personnalisable

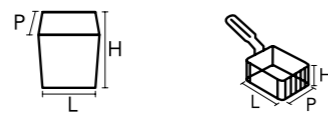

MOD.	kW	kcal		L x P x H (mm)	L x P x H (mm)	KG	REF.	€
FGS 8	5	6.076	8	330 x 540 x 370	240 x 240 x 120	10	500010	<b>898</b>
FGS 10 MAX	10	6.076	10	400 x 630 x 300	280 x 180 x 120	25	500016	<b>1776</b>
FGS 10+10 MAX	10+10	12.152	10+10	700 x 630 x 300	280 x 180 x 120	37	500017	<b>2995</b>

**G**



DATOS TÉCNICOS	TECHNICAL DATA	DONNÉES TECHNIQUES
Toma de gas 1/2"	Gas fitting 1/2"	Connexion au gaz 1/2"
Tipo gas (de fábrica) BUTANO - PROPANO	Gas type (ex-factory) BUTANE - PROPANE	Type de gaz (départ usine) BUTANE - PROPANE
Instalación de butano REGULADOR FIJO 4 kg 37 g	Butane installation FIXED REGULATOR 4 kg 37 g	Installation de butane RÉGULATEUR FIXE 4 kg 37 g

**GAS FRYERS**  
EXTERNAL BURNERS

Built in AISI304 stainless steel  
Double fryers contain double baskets in one of the tanks

- D** Adjustable working thermostat
- E** Non-slip legs
- F** Tap to drain
- G** Embedded bowl without welding
- J** Piezo electric
- K** Oil draining container



FGM 18 MAX  
FGM 24 MAX

**FRITEUSES À GAZ**  
BRÛLEURS EXTERNES

Construit en acier inoxydable AISI304  
Les friteuses doubles contiennent des paniers doubles dans l'un des bols

- D** Thermostat de travail réglable
- E** Pieds antidérapants
- F** Robinet à vidanger
- G** Bol encastrable sans soudure
- J** Piezo électrique
- K** Conteneur à vidanger l'huile



FGM 18+18 MAX

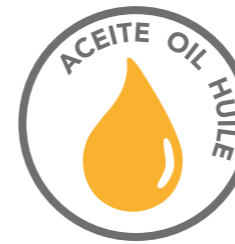

**FREIDORAS DE GAS**  
QUEMADORES EXTERNOS

Construida en acero inoxidable AISI304  
Las freidoras dobles contienen cestas partidas en una de sus cubas.

- D** Termostato trabajo regulable
- E** Patas antideslizantes
- F** Grifo de vaciado
- G** Cubeta embutida sin soldaduras
- J** Piezo eléctrico
- K** Recipiente vaciado de aceite



FGM 24+24 MAX

**G**



**FGM**



- Aceite  
Oil  
Huile
- Gas  
Gas  
Gaz
- 190°C
- Grifo  
Tap  
Robinet
- Personalizable  
Customisable  
Personnalisable

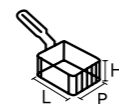
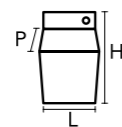

MOD.	kW	kcal		L x P x H (mm)	L x P x H (mm)	KG	REF.	€
FGM 18 MAX	14	12.040	18	400 x 730 x 850		60	500014	2667
FGM 18+18 MAX	28	20.640	18+18	800 x 730 x 850	320 x 130 x 130 (x2)	95	500015	4683
FGM 24 MAX	14	12.040	24	400 x 900 x 850		80	500018	3194
FGM 24+24 MAX	28	24.080	24+24	800 x 900 x 850	385 x 150 x 130 (x2)	115	500019	5696

**DATOS TÉCNICOS**

Toma de gas 1/2"  
Tipo gas (de fábrica) BUTANO - PROPANO  
Instalación de butano REGULADOR FIJO 4 kg 37 g

**TECHNICAL DATA**

Gas fitting 1/2"  
Gas type (ex-factory) BUTANE - PROPANE  
Butane installation FIXED REGULATOR 4 kg 37 g

**DONNÉES TECHNIQUES**

Connexion au gaz 1/2"  
Type de gaz (départ usine) BUTANE - PROPANE  
Installation de RÉGULATEUR FIXE butane 4 kg 37 g

(+34) 936 358 758

(+34) 608 299 107

pedidos@movifritofficial.com

www.movifritofficial.com





## VITRINAS

44-45 CRISTAL ABATIBLE

46-53 CRISTAL CURVO  
ABATIBLE

54-67 CRISTAL PLANO

68-69 EXPOSITORES

70-71 ENCIMERAS

## DISPLAY CASES

44-45 FOLDING GLASS

46-53 FOLDING CURVED  
GLASS

54-67 STRAIGHT GLASS

68-69 NEUTRAL DISPLAY  
CASES

70-71 COUNTERTOP

## VITRINES

44-45 VITRE ABATIBLE

46-53 VITRE ABATIBLE  
COURBÉ

54-67 VITRE PLAT

68-69 VITRINE NEUTRE

70-71 BASE FROIDE



DISPLAY CASES WITH CRYSTAL FOLDABLE

Built in AISI304 stainless steel

- B** High quality led
- F** Folding door
- G** Adjustable digital thermostat
- H** Remote compressor unit
- I** Led switch
- J** General switch

VITRINE À VITRES PLIANTES

Construit en acier inoxydable AISI304

- B** Led de haute qualité
- F** Porte abattable
- G** Thermostat digital réglable
- H** Compresseur à distance
- I** Interrupteur Led
- J** Interrupteur général

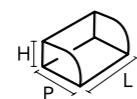

MOD.		W	V	L x P x H (mm)	KG	REF.	€
VITRINA AGATA VAR	1	160	230	1200 x 500 x 440	45	860000	2512
VITRINA AGATA VAN	1			1200 x 500 x 440	35	860001	2112



VITRINA CON CRISTAL ABATIBLE

Construida en acero inoxidable AISI304

- B** Led alta calidad
- F** Puerta abatible
- G** Termostato digital regulable
- H** Grupo compresor a distancia
- I** Interruptor Led
- J** Interruptor general

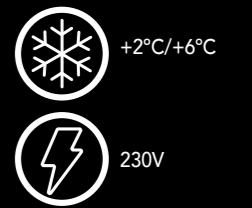

NEW

# AGATA



(+34) 936 358 758

(+34) 608 299 107

pedidos@movifritofficial.com

www.movifritofficial.com



### DISPLAY CASES WITH CURVE CRYSTAL FOLDABLE

Built in AISI304 stainless steel

- A** Folding glass (easy cleaning)
- B** High quality led
- C** Trays included
- D** Cuba without angles
- E** 21 cm to support plates
- F** Sliding doors
- G** Adjustable digital thermostat
- H** Hermetic compressor with ventilated condenser
- I** Led switch
- J** General switch

### VITRINE À VITRES COURBÉES PLIANTES

Construit en acier inoxydable AISI304

- A** Vitre abattable (facil nettoyage)
- B** Led de haute qualité
- C** Plateaux inclus
- D** Cuba sans angles
- E** 21 cm pour support planchas
- F** Portes coulissantes
- G** Thermostat digital réglable
- H** Compresseur hermétique avec condenseur ventilé
- I** Interrupteur Led
- J** Interrupteur général

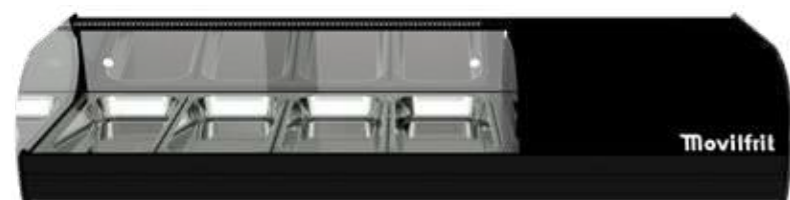

IRON 4



IRON 6



IRON 8

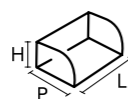

MOD.		W	V	L x P x H (mm)	KG	REF.	€	REF.	REF.	€
IRON 4	4 x GN1/3 x 40	160	230	1146 x 390 x 215	24	877015	<b>1223</b>	877024	877021	<b>1268</b>
IRON 6	6 x GN1/3 x 40			1487 x 390 x 215	34	877016	<b>1325</b>	877025	877022	<b>1374</b>
IRON 8	8 x GN1/3 x 40			1826 x 390 x 215	40	877017	<b>1475</b>	877026	877023	<b>1530</b>
IRON 6 REMOTA	6 x GN1/3 x 40			1146 x 390 x 215	32	876909	<b>1327</b>	-	-	
IRON 8 REMOTA	8 x GN1/3 x 40			1487 x 390 x 215	35	876910	<b>1459</b>	-	-	
IRON 4 CUBA PLANA	-			1146 x 390 x 215	24	877033	<b>1223</b>	877039	877036	<b>1268</b>
IRON 6 CUBA PLANA	-			1487 x 390 x 215	34	877034	<b>1325</b>	877040	877037	<b>1374</b>
IRON 8 CUBA PLANA	-			1826 x 390 x 215	40	877035	<b>1475</b>	877041	877038	<b>1530</b>
IRON 6 REMOTA CUBA PLANA	-			1146 x 390 x 215	32	876912	<b>1327</b>	-	-	
IRON 8 REMOTA CUBA PLANA	-			1487 x 390 x 215	35	876913	<b>1459</b>	-	-	



### VITRINA CON CRISTAL CURVO ABATIBLE

Construida en acero inoxidable AISI304

- A** Cristal abatible (fácil limpieza)
- B** Led alta calidad
- C** Bandejas incluidas
- D** Cuba sin ángulos
- E** 21 cm para apoyar platos
- F** Puertas correderas
- G** Termostato digital regulable
- H** Compresor hermético con condensador ventilado
- I** Interruptor Led
- J** Interruptor general

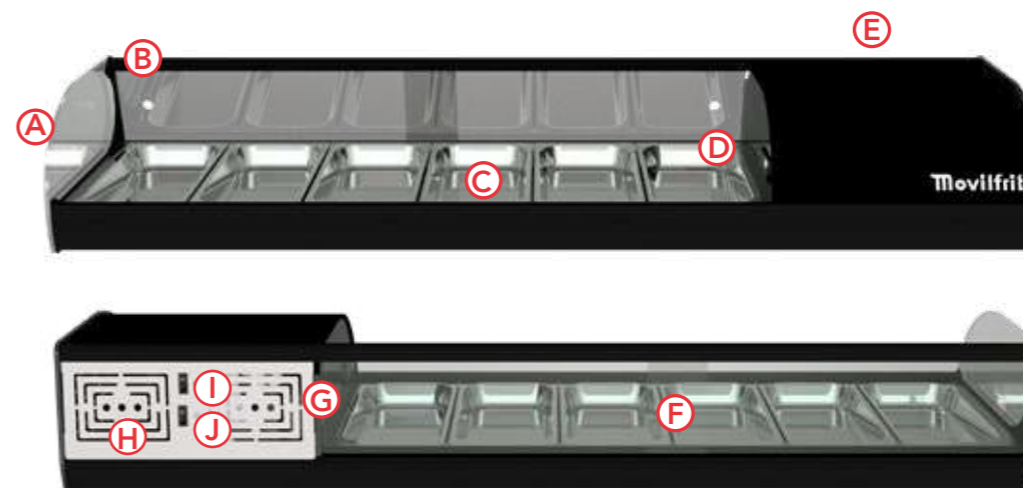

- ✓ CRISTAL TEMPLADO ANTI-ROTURA CON MAYOR AISLAMIENTO TÉRMICO.
- ✓ MEJOR ESTABILIDAD DE TEMPERATURA.
- ✓ MENOR CONSUMO.

# IRON 1 PISO

- +2°C/+6°C
- 230V
- Led
- Bandejas  
Trays  
Plateaux
- Colores  
Colours  
Couleurs
- Personalizable  
Customisable  
Personnalisable

#### ACCESORIOS NO INCLUIDOS

#### ACCESORIES NOT INCLUDED

#### ACCESSOIRES NON INCLUS

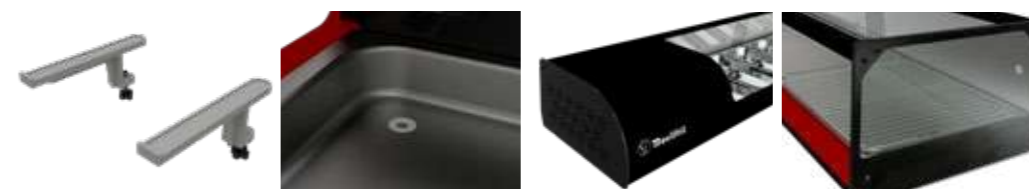

Juego soportes Bracket set Kit de fixation	Kit desagüe Drain kit Kit de vidange	Motor lado contrario Motor on opposite side Moteur côté opposé	Parrillas inox cuba plana SS grills flat bowl Grilles en acier inox. Cuvette plate
REF.	REF.	REF.	REF.
916872	905415	300	918361
€ x 2	€ x 1	€ x 1	€ x 1
<b>111,21</b>	<b>65,00</b>	<b>115,39</b>	<b>36,00</b>

(+34) 936 358 758

(+34) 608 299 107

pedidos@movifritofficial.com

www.movifritofficial.com

DISPLAY CASES WITH CURVE CRYSTAL FOLDABLE

Built in AISI304 stainless steel

- (A) Folding glass (easy cleaning)
- (B) High quality led
- (C) Trays included
- (D) Cuba without angles
- (E) 21 cm to support plates
- (F) Sliding doors
- (G) Adjustable digital thermostat
- (H) Hermetic compressor with ventilated condenser
- (I) Led switch
- (J) General switch
- (K) Upper evaporator

VITRINE À VITRES COURBÉES PLIANTES

Construit en acier inoxydable AISI304

- (A) Vitre abattable (facil nettoyage)
- (B) Led de haute qualité
- (C) Plateaux inclus
- (D) Cuba sans angles
- (E) 21 cm pour support planchas
- (F) Portes coulissantes
- (G) Thermostat digital réglable
- (H) Compresseur hermétique avec condenseur ventilé
- (I) Interrupteur Led
- (J) Interrupteur général
- (K) Évaporateur supérieur sushi



IRON 4



IRON 6



IRON 8



VITRINA CON CRISTAL CURVO ABATIBLE

Construida en acero inoxidable AISI304

- (A) Cristal abatible (fácil limpieza)
- (B) Led alta calidad
- (C) Bandejas incluidas
- (D) Cuba sin ángulos
- (E) 21 cm para apoyar platos
- (F) Puertas correderas
- (G) Termostato digital regulable
- (H) Compresor hermético con condensador ventilado
- (I) Interruptor Led
- (J) Interruptor general
- (K) Evaporador superior sushi

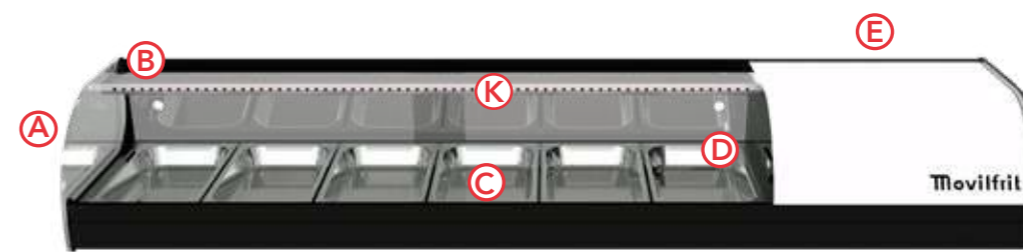

- ✓ CRISTAL TEMPLADO ANTI-ROTURA CON MAYOR AISLAMIENTO TÉRMICO.
- ✓ MEJOR ESTABILIDAD DE TEMPERATURA.
- ✓ MENOR CONSUMO.

IRON SUSHI

- +2°C/+6°C
- 230V
- Led
- Bandejas  
Trays  
Plateaux
- Colores  
Colours  
Couleurs
- Personalizable  
Customisable  
Personnalisable

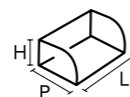

MOD.		W	V	L x P x H (mm)	KG	REF.	€	REF.	REF.	€
IRON 4 SUSHI	4 x GN1/3 x 40	160	230	1146 x 390 x 215	24	877042	<b>1369</b>	877048	877045	<b>1420</b>
IRON 6 SUSHI	6 x GN1/3 x 40			1487 x 390 x 215	34	877043	<b>1455</b>	877049	877046	<b>1509</b>
IRON 8 SUSHI	8 x GN1/3 x 40			1826 x 390 x 215	40	877044	<b>1655</b>	877050	877047	<b>1716</b>
IRON 4 SUSHI CUBA PLANA	4 x GN1/3 x 40			1146 x 390 x 215	24	877051	<b>1369</b>	877057	877054	<b>1420</b>
IRON 6 SUSHI CUBA PLANA	6 x GN1/3 x 40			1487 x 390 x 215	34	877052	<b>1455</b>	877058	877055	<b>1509</b>
IRON 8 SUSHI CUBA PLANA	8 x GN1/3 x 40			1826 x 390 x 215	40	877053	<b>1655</b>	877059	877056	<b>1716</b>

ACCESORIOS NO INCLUIDOS

ACCESORIES NOT INCLUDED

ACCESSOIRES NON INCLUS

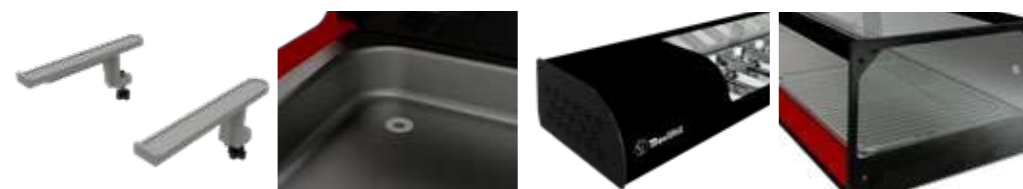

Juego soportes Bracket set Kit de fixation		Kit desagüe Drain kit Kit de vidange		Motor lado contrario Motor on opposite side Moteur côté opposé		Parrillas inox cuba plana SS grills flat bowl Grilles en acier inox. Cuvette plate	
REF.	€ x 2	REF.	€ x 1	REF.	€ x 1	REF.	€ x 1
916872	<b>111,21</b>	905415	<b>65,00</b>	300	<b>115,39</b>	918361	<b>36,00</b>

(+34) 936 358 758

(+34) 608 299 107

pedidos@movifritofficial.com

www.movifritofficial.com



### DISPLAY CASES WITH CURVE CRYSTAL FOLDABLE

Built in AISI304 stainless steel

- (A) Folding glass (easy cleaning)
- (B) High quality led
- (C) Trays included
- (D) Cuba without angles
- (E) 21 cm to support plates
- (F) Sliding doors
- (G) Adjustable digital thermostat
- (H) Hermetic compressor with ventilated condenser
- (I) Led switch
- (J) General switch

### VITRINE À VITRES COURBÉES PLIANTES

Construit en acier inoxydable AISI304

- (A) Vitre abattable (facil nettoyage)
- (B) Led de haute qualité
- (C) Plateaux inclus
- (D) Cuba sans angles
- (E) 21 cm pour support planchas
- (F) Portes coulissantes
- (G) Thermostat digital réglable
- (H) Compresseur hermétique avec condenseur ventilé
- (I) Interrupteur Led
- (J) Interrupteur général



IRON 4



IRON 6



IRON 8

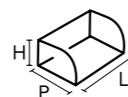

MOD.		W	V	L x P x H (mm)	KG	REF.	€	REF.	€
IRON 4 2P	4 x GN1/3 x 40	160	230	1146 x 390 x 315	30	877018	<b>1314</b>	877030 877027	<b>1363</b>
IRON 6 2P	6 x GN1/3 x 40			1487 x 390 x 315	43	877019	<b>1420</b>	877031 877028	<b>1473</b>
IRON 8 2P	8 x GN1/3 x 40			1826 x 390 x 315	51	877020	<b>1585</b>	877032 877029	<b>1644</b>
IRON 6 2P REMOTA	6 x GN1/3 x 40			1146 x 390 x 315	38	876916	<b>1530</b>	- -	
IRON 8 2P REMOTA	8 x GN1/3 x 40			1487 x 390 x 315	45	876917	<b>1681</b>	- -	
IRON 4 2P CUBA PLANA	4 x GN1/3 x 40			1146 x 390 x 315	30	877060	<b>1314</b>	877090 877091	<b>1363</b>
IRON 6 2P CUBA PLANA	6 x GN1/3 x 40			1487 x 390 x 315	43	877061	<b>1420</b>	877092 877093	<b>1473</b>
IRON 8 2P CUBA PLANA	8 x GN1/3 x 40			1826 x 390 x 315	51	877062	<b>1585</b>	877094 877095	<b>1644</b>
IRON 6 2P REMOTA CUBA PLANA	6 x GN1/3 x 40			1146 x 390 x 315	38	876914	<b>1530</b>	- -	
IRON 8 2P REMOTA CUBA PLANA	8 x GN1/3 x 40			1487 x 390 x 315	45	876915	<b>1681</b>	- -	



### VITRINA CON CRISTAL CURVO ABATIBLE

Construida en acero inoxidable AISI304

- (A) Cristal abatible (fácil limpieza)
- (B) Led alta calidad
- (C) Bandejas incluidas
- (D) Cuba sin ángulos
- (E) 21 cm para apoyar platos
- (F) Puertas correderas
- (G) Termostato digital regulable
- (H) Compresor hermético con condensador ventilado
- (I) Interruptor Led
- (J) Interruptor general

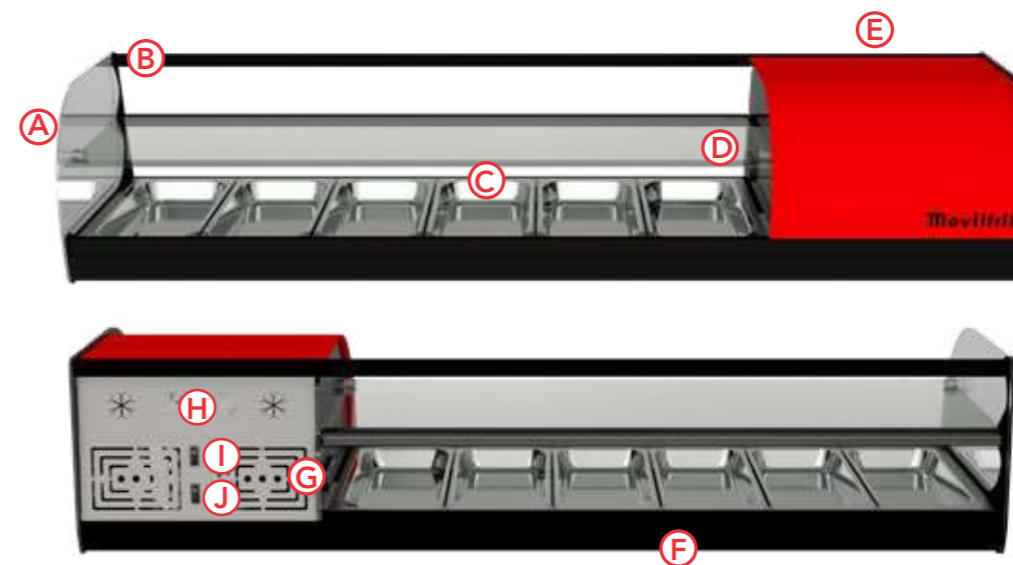

- ✓ CRISTAL TEMPLADO ANTI-ROTURA CON MAYOR AISLAMIENTO TÉRMICO.
- ✓ MEJOR ESTABILIDAD DE TEMPERATURA.
- ✓ MENOR CONSUMO.

# IRON 2 PISOS

- +2°C/+6°C
- 230V
- Led
- Bandejas  
Trays  
Plateaux
- Colores  
Colours  
Couleurs
- Personalizable  
Customisable  
Personnalisable

ACCESORIOS NO INCLUIDOS	ACCESORIES NOT INCLUDED	ACCESSOIRES NON INCLUS
Juego soportes Bracket set	Kit desagüe Drain kit	Motor lado contrario Motor on opposite side
Kit de fixation	Kit de vidange	Moteur côté opposé
REF. € x 2	REF. € x 1	REF. € x 1
916872 <b>111,21</b>	905415 <b>65,00</b>	300 <b>115,39</b>
		Parrillas inox cuba plana SS grills flat bowl
		Grilles en acier inox. Cuvette plate
		REF. € x 1
		918361 <b>36,00</b>

(+34) 936 358 758

(+34) 608 299 107

pedidos@movifritofficial.com

www.movifritofficial.com

DISPLAY CASES WITH CURVE CRYSTAL FOLDABLE

Built in AISI304 stainless steel

- (A) Folding glass (easy cleaning)
- (B) High quality led
- (C) Trays included
- (D) Cuba without angles
- (E) 21 cm to support plates
- (F) Sliding doors
- (G) Adjustable annual thermostat
- (H) Led switch
- (I) General switch
- (L) Drain

VITRINE À VITRES COURBÉES PLIANTES

Construit en acier inoxydable AISI304

- (A) Vitre abattable (facil nettoyage)
- (B) Led de haute qualité
- (C) Plateaux inclus
- (D) Cuba sans angles
- (E) 21 cm pour support planchas
- (F) Portes coulissantes
- (G) Thermostat manuel réglable
- (H) Interrupteur Led
- (I) Interrupteur général
- (L) Vidanger



IRON 4



IRON 6



VITRINA CON CRISTAL CURVO ABATIBLE

Construida en acero inoxidable AISI304

- (A) Cristal abatible (fácil limpieza)
- (B) Led alta calidad
- (C) Bandejas incluidas
- (D) Cuba sin ángulos
- (E) 21 cm para apoyar platos
- (F) Puertas correderas
- (G) Termostato manual regulable
- (H) Interruptor Led
- (I) Interruptor general
- (L) Desagüe

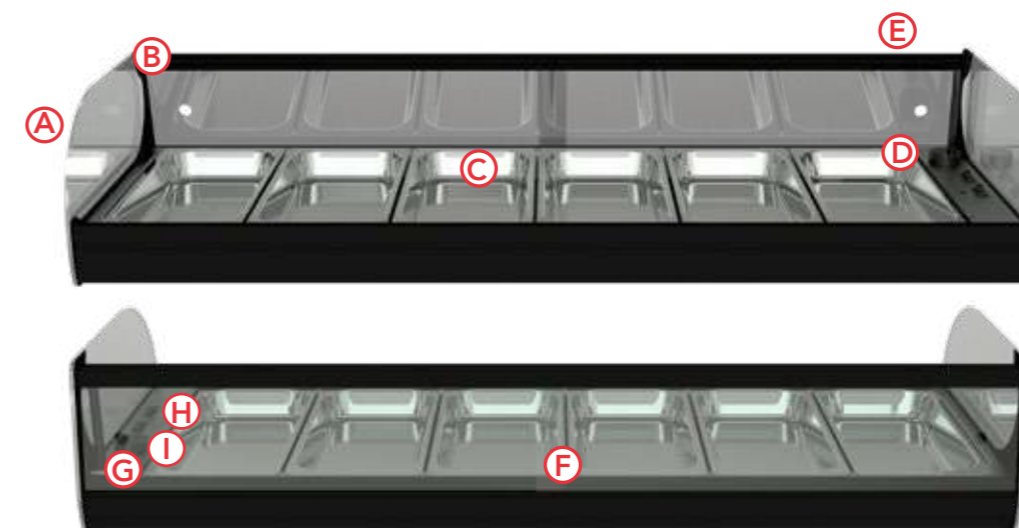

- ✓ CRISTAL TEMPLADO ANTI-ROTURA CON MAYOR AISLAMIENTO TÉRMICO. (L)
- ✓ MEJOR ESTABILIDAD DE TEMPERATURA.
- ✓ MENOR CONSUMO.

IRON CALENTADOR

- 0°C/90°C
- 230V
- Led
- Bandejas  
Trays  
Plateaux
- Personalizable  
Customisable  
Personnalisable

ACCESORIOS NO INCLUIDOS

ACCESORIES NOT INCLUDED

ACCESSOIRES NON INCLUS



Juego soportes Bracket set Kit de fixation	
REF.	€ x 2
916872	111,21

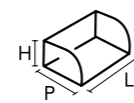

MOD.		W	V	L x P x H (mm)	KG	REF.	€
IRON 4 CALENTADOR BAÑO MARIA	4 x GN1/3 x 40	1000	230	807 x 390 x 215	20	807094	780
IRON 6 CALENTADOR BAÑO MARIA	6 x GN1/3 x 40			1146 x 390 x 215	28	807095	925



DISPLAY CASES WITH FLAT CRYSTAL

- Built in AISI304 stainless steel
- G** Adjustable digital thermostat
- H** Hermetic compressor with ventilated condenser
- J** General switch

VITRINE À VITRES PLATS

- Construit en acier inoxydable AISI304
- G** Thermostat digital réglable
- H** Compresseur hermétique avec condenseur ventilé
- J** Interrupteur général



Cub V2



Cub V3



Cub V4



VITRINA CON CRISTAL PLANO

- Construida en acero inoxidable AISI304
- G** Termostato digital regulable
- H** Compresor hermético con condensador ventilado
- J** Interruptor general

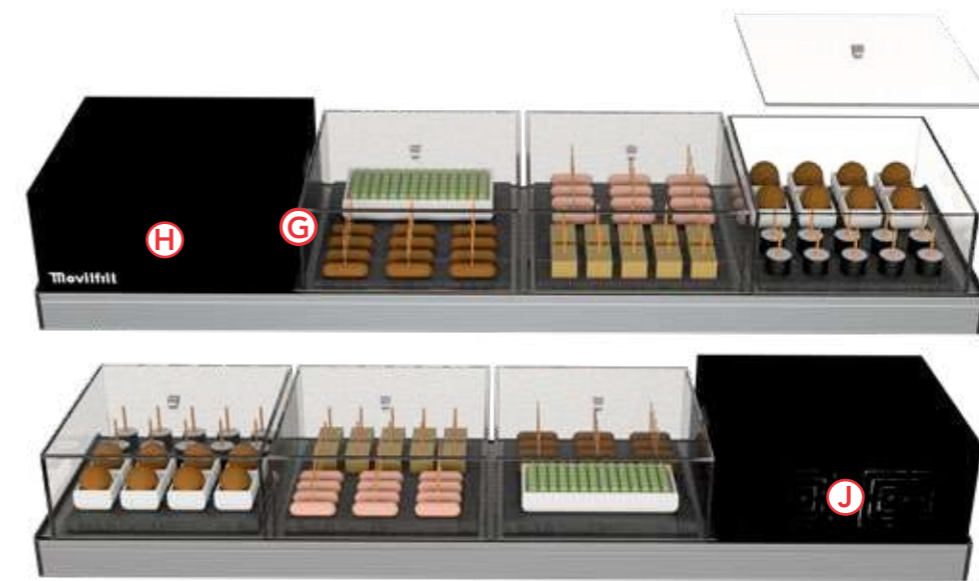

**NEW**  
**CUB**  
**SELF-SERVICE**

- +2°C/+6°C
- 230V
- Colores  
Colours  
Couleurs
- Personalizable  
Customisable  
Personnalisable

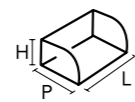

MOD.			W	V	L x P x H (mm)	KG	REF.	€
CUB SELF-SERVICE V4	2		160	230	1146 x 390 x 252	24	308030	1111
CUB SELF-SERVICE V6	3	1487 x 390 x 252			34	308031	1217	
CUB SELF-SERVICE V8	4	1826 x 390 x 252			40	308032	1397	

(+34) 936 358 758

(+34) 608 299 107

pedidos@movifritofficial.com

www.movifritofficial.com

DISPLAY CASES WITH FLAT CRYSTAL

Built in AISI304 stainless steel

- B** High quality led
- C** Trays included
- D** Cuba without angles
- E** 34 cm to support plates
- F** Sliding doors
- G** Adjustable digital thermostat
- H** Hermetic compressor with ventilated condenser
- I** Led switch
- J** General switch

VITRINE À VITRES PLATS

Construit en acier inoxydable AISI304

- B** Led de haute qualité
- C** Plateaux inclus
- D** Cuba sans angles
- E** 34 cm pour support planchas
- F** Portes coulissantes
- G** Thermostat digital réglable
- H** Compresseur hermétique avec condenseur ventilé
- I** Interrupteur Led
- J** Interrupteur général



CUB 4



CUB 6



CUB 8

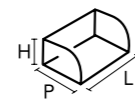

MOD.			W	V	L x P x H (mm)	KG	REF.	€	REF.	€
CUB 4	4 x GN1/3 x 40	160 230			1146 x 390 x 252	24	307000	1262	307003 307006	1309
CUB 6	6 x GN1/3 x 40				1487 x 390 x 252	34	307001	1384	307004 307007	1435
CUB 8	8 x GN1/3 x 40				1826 x 390 x 252	40	307002	1560	307005 307008	1618
CUB 4 CUBA PLANA	-				1146 x 390 x 252	24	306990	1262	306993 306996	1309
CUB 6 CUBA PLANA	-				1487 x 390 x 252	34	306991	1384	306994 306997	1435
CUB 8 CUBA PLANA	-				1826 x 390 x 252	40	306992	1560	306995 306998	1618
CUB 4 REMOTA	4 x GN1/3 x 40				805 x 390 x 252	22	307009	1416	- -	
CUB 6 REMOTA	6 x GN1/3 x 40				1146 x 390 x 252	32	307010	1560	- -	
CUB 8 REMOTA	8 x GN1/3 x 40				1487 x 390 x 252	38	307011	1713	- -	



VITRINA CON CRISTAL PLANO

Construida en acero inoxidable AISI304

- B** Led alta calidad
- C** Bandejas incluidas
- D** Cuba sin ángulos
- E** 34 cm para apoyar platos
- F** Puertas correderas
- G** Termostato digital regulable
- H** Compresor hermético con condensador ventilado
- I** Interruptor Led
- J** Interruptor general

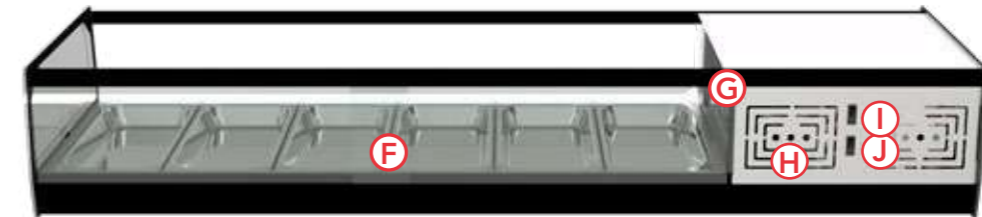
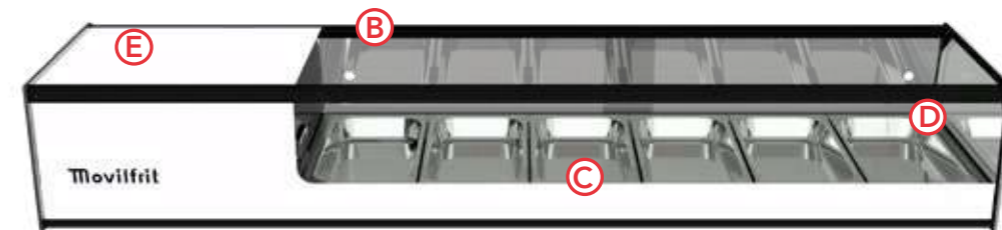

- ✓ DOBLE ACRISTALAMIENTO DE SEGURIDAD.
- ✓ MEJOR ESTABILIDAD Y AISLAMIENTO DE TEMPERATURA.
- ✓ MENOR CONSUMO.

CUB 1 PISO

- +2°C/+6°C
- 230V
- Led
- Bandejas  
Trays  
Plateaux
- Colores  
Colours  
Couleurs
- Personalizable  
Customisable  
Personnalisable

ACCESORIOS NO INCLUIDOS / ACCESSORIES NOT INCLUDED / ACCESSOIRES NON INCLUS

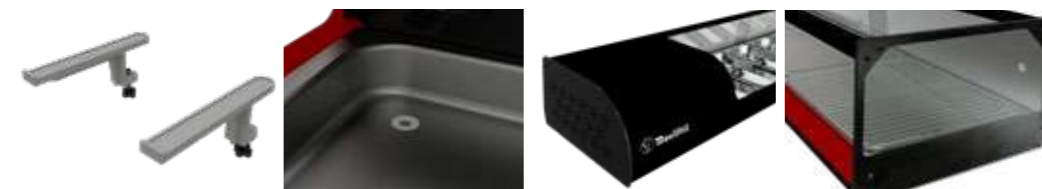

Juego soportes Bracket set Kit de fixation		Kit desagüe Drain kit Kit de vidange		Motor lado contrario Motor on opposite side Moteur côté opposé		Parrillas inox cuba plana SS grills flat bowl Grilles en acier inox. Cuvette plate	
REF.	€ x 2	REF.	€ x 1	REF.	€ x 1	REF.	€ x 1
916872	111,21	905415	65,00	300	115,39	918361	36,00

(+34) 936 358 758

(+34) 608 299 107

pedidos@movifritofficial.com

www.movifritofficial.com



DISPLAY CASES WITH FLAT CRYSTAL

Built in AISI304 stainless steel

- B** High quality led
- C** Trays included
- D** Cuba without angles
- E** 34 cm to support plates
- F** Sliding doors
- G** Adjustable digital thermostat
- H** Hermetic compressor with ventilated condenser
- I** Led switch
- J** General switch
- K** Upper evaporator

VITRINE À VITRES PLATS

Construit en acier inoxydable AISI304

- B** Led de haute qualité
- C** Plateaux inclus
- D** Cuba sans angles
- E** 34 cm pour support planchas
- F** Portes coulissantes
- G** Thermostat digital réglable
- H** Compresseur hermétique avec condenseur ventilé
- I** Interrupteur Led
- J** Interrupteur général
- K** Évaporateur supérieur sushi

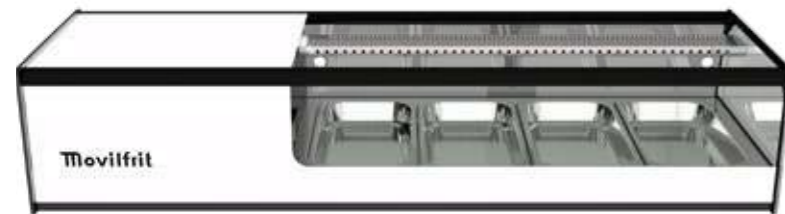

CUB 4



CUB 6



CUB 8



VITRINA CON CRISTAL PLANO

Construida en acero inoxidable AISI304

- B** Led alta calidad
- C** Bandejas incluidas
- D** Cuba sin ángulos
- E** 34 cm para apoyar platos
- F** Puertas correderas
- G** Termostato digital regulable
- H** Compresor hermético con condensador ventilado
- I** Interruptor Led
- J** Interruptor general
- K** Evaporador superior sushi

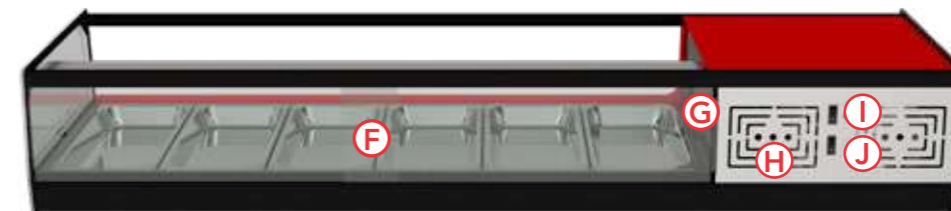
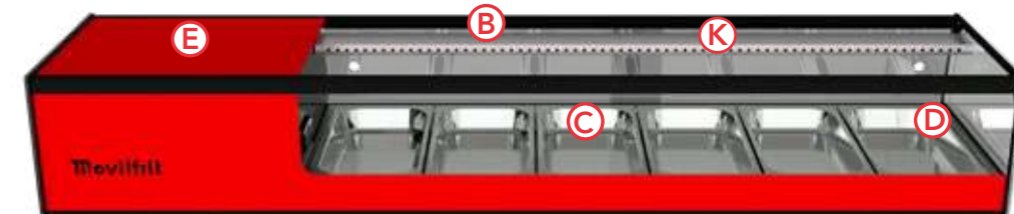

- ✓ DOBLE ACRISTALAMIENTO DE SEGURIDAD.
- ✓ MEJOR ESTABILIDAD Y AISLAMIENTO DE TEMPERATURA.
- ✓ MENOR CONSUMO.

CUB SUSHI

- +2°C/+6°C
- 230V
- Led
- Bandejas  
Trays  
Plateaux
- Colores  
Colours  
Couleurs
- Personalizable  
Customisable  
Personnalisable

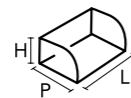

MOD.		W	V	L x P x H (mm)	KG	REF.	€	REF.	€	
CUB 4 SUSHI	4 x GN1/3 x 40	160	230	1146 x 390 x 252	24	308010	1410	308013	308016	1462
CUB 6 SUSHI	6 x GN1/3 x 40			1487 x 390 x 252	34	308011	1547	308014	308017	1604
CUB 8 SUSHI	8 x GN1/3 x 40			1826 x 390 x 252	40	308012	1725	308015	308018	1789
CUB 4 SUSHI CUBA PLANA	4 x GN1/3 x 40			1146 x 390 x 252	24	308020	1410	308023	308026	1462
CUB 6 SUSHI CUBA PLANA	6 x GN1/3 x 40			1487 x 390 x 252	34	308021	1547	308024	308027	1604
CUB 8 SUSHI CUBA PLANA	8 x GN1/3 x 40			1826 x 390 x 252	40	308022	1725	308025	308028	1789

ACCESORIOS NO INCLUIDOS

ACCESORIES NOT INCLUDED

ACCESSOIRES NON INCLUS

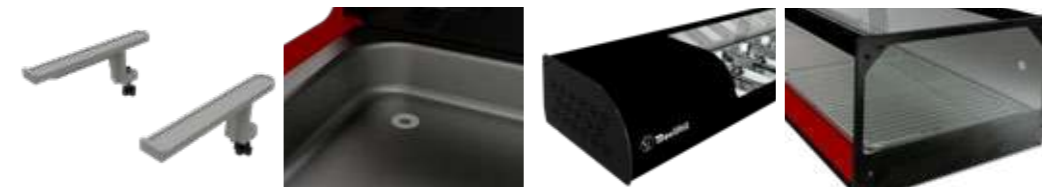

Juego soportes Bracket set Kit de fixation		Kit desagüe Drain kit Kit de vidange		Motor lado contrario Motor on opposite side Moteur côté opposé		Parrillas inox cuba plana SS grills flat bowl Grilles en acier inox. Cuvette plate	
REF.	€ x 2	REF.	€ x 1	REF.	€ x 1	REF.	€ x 1
916872	111,21	905415	65,00	300	115,39	918361	36,00

DISPLAY CASES WITH FLAT CRYSTAL

Built in AISI304 stainless steel

- B** High quality led
- C** Trays included
- D** Cuba without angles
- E** 34 cm to support plates
- F** Sliding doors
- G** Adjustable digital thermostat
- H** Hermetic compressor with ventilated condenser
- I** Led switch
- J** General switch

VITRINE À VITRES PLATS

Construit en acier inoxydable AISI304

- B** Led de haute qualité
- C** Plateaux inclus
- D** Cuba sans angles
- E** 34 cm pour support planchas
- F** Portes coulissantes
- G** Thermostat digital réglable
- H** Compresseur hermétique avec condenseur ventilé
- I** Interrupteur Led
- J** Interrupteur général

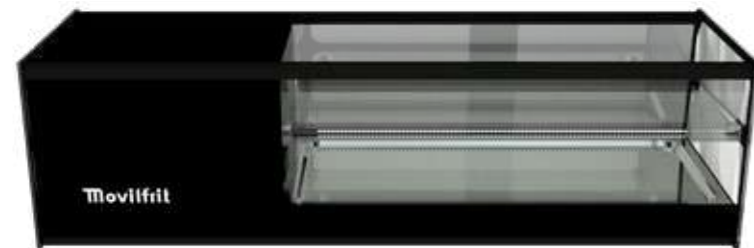

CUB 4

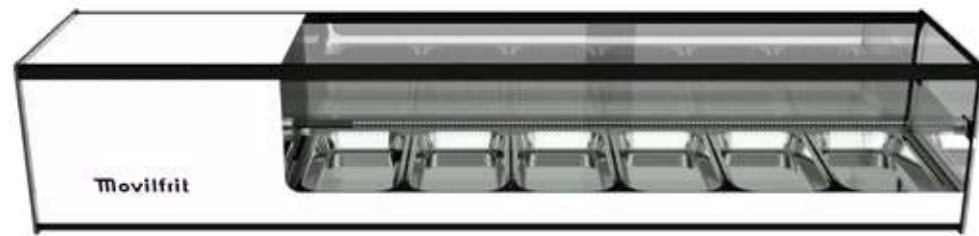

CUB 6



CUB 8

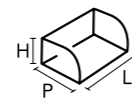

MOD.	W	V	L x P x H (mm)	KG	REF.	€	REF.	€
CUB 4 2P	4 x GN1/3 x 40	160	230	1146 x 390 x 330	24	307069	1500	307075 307078 1556
CUB 6 2P	6 x GN1/3 x 40			1487 x 390 x 330	34	307070	1628	307076 307079 1688
CUB 8 2P	8 x GN1/3 x 40			1526 x 390 x 330	40	307071	1744	307077 307080 1809
CUB 4 2P CUBA PLANA	-			1146 x 390 x 330	24	307074	1500	307081 307084 1556
CUB 6 2P CUBA PLANA	-			1487 x 390 x 330	34	307072	1628	307082 307085 1688
CUB 8 2P CUBA PLANA	-			1526 x 390 x 330	40	307073	1744	307083 307086 1809
CUB 4 2P REMOTA	4 x GN1/3 x 40			805 x 390 x 330	22	307012	1681	- -
CUB 6 2P REMOTA	6 x GN1/3 x 40			1146 x 390 x 330	32	307013	1786	- -
CUB 8 2P REMOTA	8 x GN1/3 x 40			1487 x 390 x 330	38	307014	1843	- -



VITRINA CON CRISTAL PLANO

Construida en acero inoxidable AISI304

- B** Led alta calidad
- C** Bandejas incluidas
- D** Cuba sin ángulos
- E** 34 cm para apoyar platos
- F** Puertas correderas
- G** Termostato digital regulable
- H** Compresor hermético con condensador ventilado
- I** Interruptor Led
- J** Interruptor general

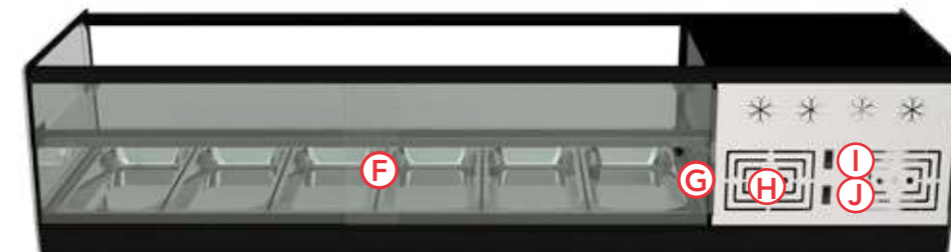
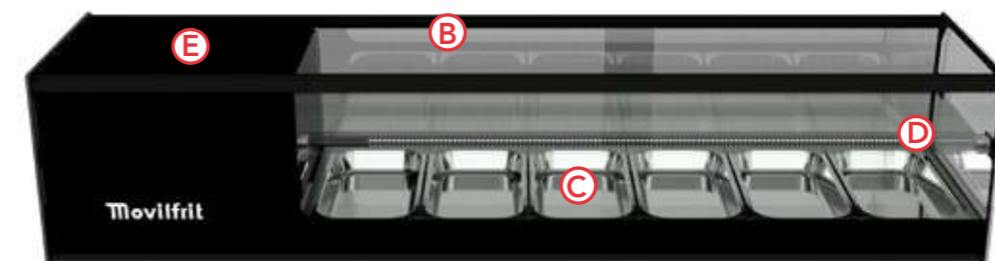

- ✓ DOBLE ACRISTALAMIENTO DE SEGURIDAD.
- ✓ MEJOR ESTABILIDAD Y AISLAMIENTO DE TEMPERATURA.
- ✓ MENOR CONSUMO.

CUB 2 PISOS

- +2°C/+6°C
- 230V
- Led
- Bandejas  
Trays  
Plateaux
- Colores  
Colours  
Couleurs
- Personalizable  
Customisable  
Personnalisable

ACCESORIOS NO INCLUIDOS / ACCESORIES NOT INCLUDED / ACCESSOIRES NON INCLUS

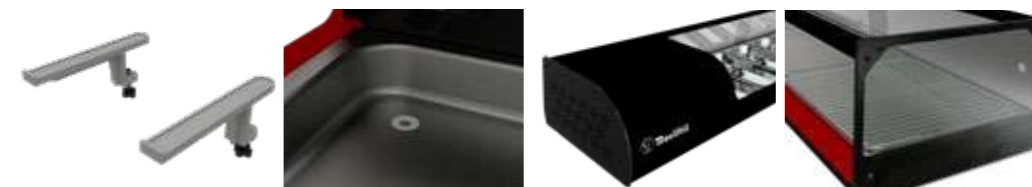

ACCESORIO	ACCESORIES	ACCESOIRES
Juego soportes Bracket set Kit de fixation	Kit desagüe Drain kit Kit de vidange	Motor lado contrario Motor on opposite side Moteur côté opposé
REF. € x 2	REF. € x 1	REF. € x 1
916872 111,21	905415 65,00	300 115,39
		Parrillas inox cuba plana SS grills flat bowl Grilles en acier inox. Cuvette plate
		REF. € x 1
		918361 36,00

(+34) 936 358 758

(+34) 608 299 107

pedidos@movifritofficial.com

www.movifritofficial.com



DISPLAY CASES WITH FLAT CRYSTAL

Built in AISI304 stainless steel

- B** High quality led
- C** Trays included
- D** Cuba without angles
- E** 34 cm to support plates
- F** Sliding doors
- G** Adjustable digital thermostat
- H** Hermetic compressor with ventilated condenser
- I** Led switch
- J** General switch

VITRINE À VITRES PLATS

Construit en acier inoxydable AISI304

- B** Led de haute qualité
- C** Plateaux inclus
- D** Cuba sans angles
- E** 34 cm pour support planchas
- F** Portes coulissantes
- G** Thermostat digital réglable
- H** Compresseur hermétique avec condenseur ventilé
- I** Interrupteur Led
- J** Interrupteur général

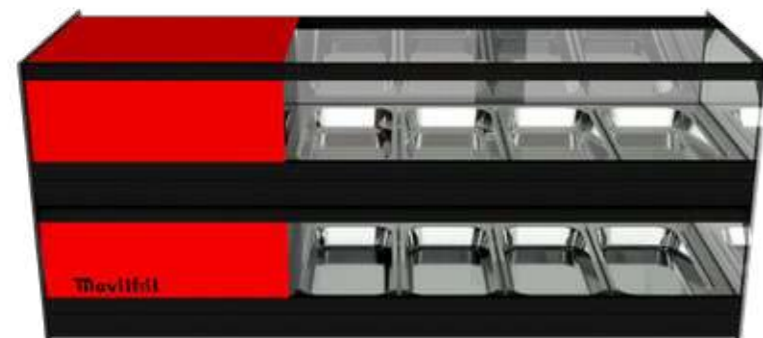

CUB 4

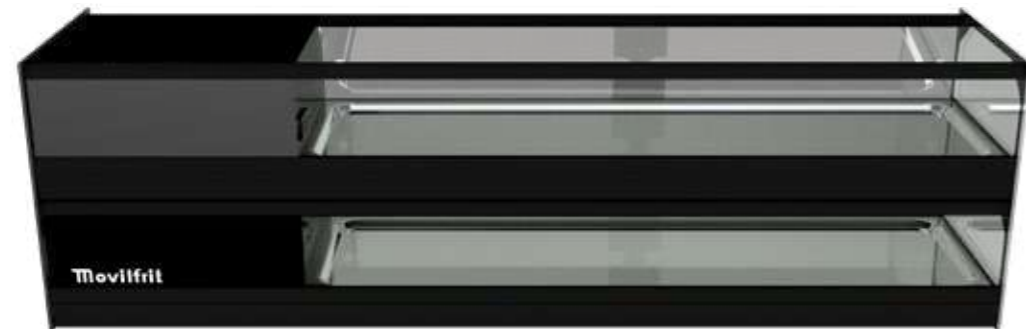

CUB 6



VITRINA CON CRISTAL PLANO

Construida en acero inoxidable AISI304

- B** Led alta calidad
- C** Bandejas incluidas
- D** Cuba sin ángulos
- E** 34 cm para apoyar platos
- F** Puertas correderas
- G** Termostato digital regulable
- H** Compresor hermético con condensador ventilado
- I** Interruptor Led
- J** Interruptor general

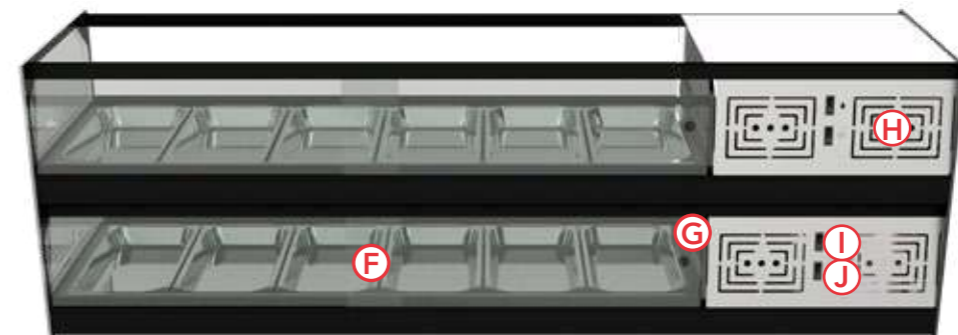
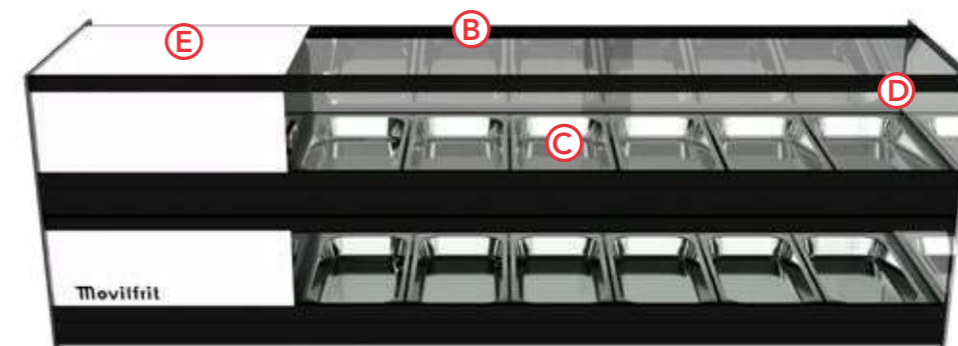

- ✓ DOBLE ACRISTALAMIENTO DE SEGURIDAD.
- ✓ MEJOR ESTABILIDAD Y AISLAMIENTO DE TEMPERATURA.
- ✓ MENOR CONSUMO.

CUB COLD 2

- +2°C/+6°C
- 230V
- Led
- Bandejas  
Trays  
Plateaux
- Colores  
Colours  
Couleurs
- Personalizable  
Customisable  
Personnalisable

ACCESORIOS NO INCLUIDOS

ACCESORIES NOT INCLUDED

ACCESSOIRES NON INCLUS

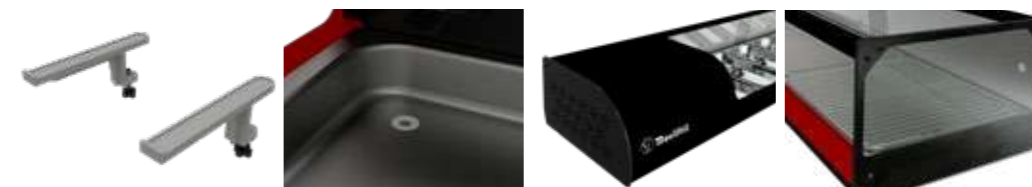

Juego soportes Bracket set		Kit desagüe Drain kit		Motor lado contrario Motor on opposite side		Parrillas inox cuba plana SS grills flat bowl	
REF.	€ x 2	REF.	€ x 1	REF.	€ x 1	REF.	€ x 1
916872	111,21	905415	65,00	300	115,39	918361	36,00

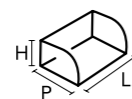

MOD.			W	V	L x P x H (mm)	KG	REF.	€	REF.	€	
CUB COLD 4 2P	2	8 x GN1/3 x 40	160	230	1146 x 390 x 515	48	306984	2279	306985	306986	2364
CUB COLD 6 2P	2	12 x GN1/3 x 40	160	230	1487 x 390 x 515	68	306987	2480	306988	306989	2572

DISPLAY CASES WITH FLAT CRYSTAL

Built in AISI304 stainless steel

- B** High quality led
- C** Trays included
- D** Cuba without angles
- E** 34 cm to support plates
- F** Sliding doors
- G** Adjustable digital thermostat
- H** Hermetic compressor with ventilated condenser
- I** Led switch
- J** General switch

VITRINE À VITRES PLATS

Construit en acier inoxydable AISI304

- B** Led de haute qualité
- C** Plateaux inclus
- D** Cuba sans angles
- E** 34 cm pour support planchas
- F** Portes coulissantes
- G** Thermostat digital réglable
- H** Compresseur hermétique avec condenseur ventilé
- I** Interrupteur Led
- J** Interrupteur général



CUB 4

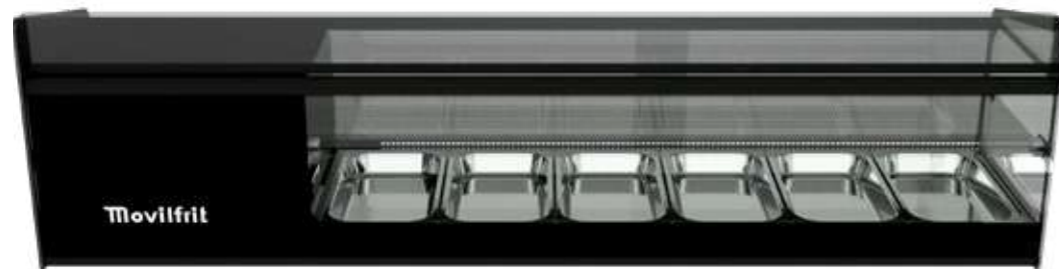

CUB 6

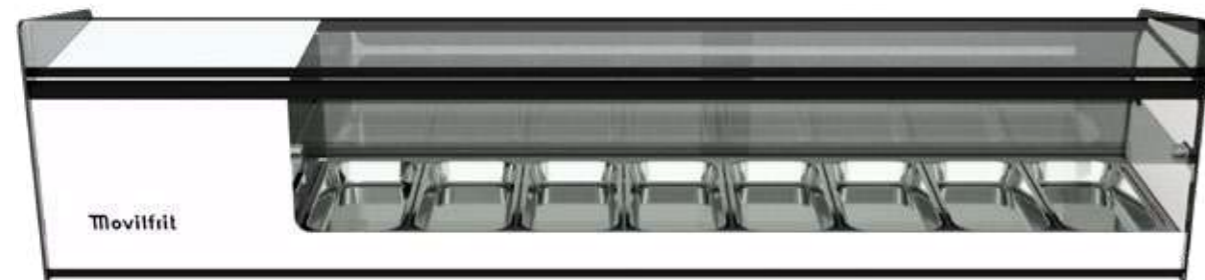

CUB 8

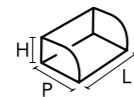

MOD.		W	V	L x P x H (mm)	KG	REF.	€	REF.	€	
CUB TOP 4	4 x GN1/3 x 40	160	230	1146 x 390 x 405	24	308000	<b>1634</b>	308001	308002	<b>1694</b>
CUB TOP 6	6 x GN1/3 x 40			1487 x 390 x 405	34	308003	<b>1762</b>	308004	308005	<b>1827</b>
CUB TOP 8	8 x GN1/3 x 40			1826 x 390 x 405	40	308006	<b>1879</b>	308007	308008	<b>1949</b>



VITRINA CON CRISTAL PLANO

Construida en acero inoxidable AISI304

- B** Led alta calidad
- C** Bandejas incluidas
- D** Cuba sin ángulos
- E** 34 cm para apoyar platos
- F** Puertas correderas
- G** Termostato digital regulable
- H** Compresor hermético con condensador ventilado
- I** Interruptor Led
- J** Interruptor general

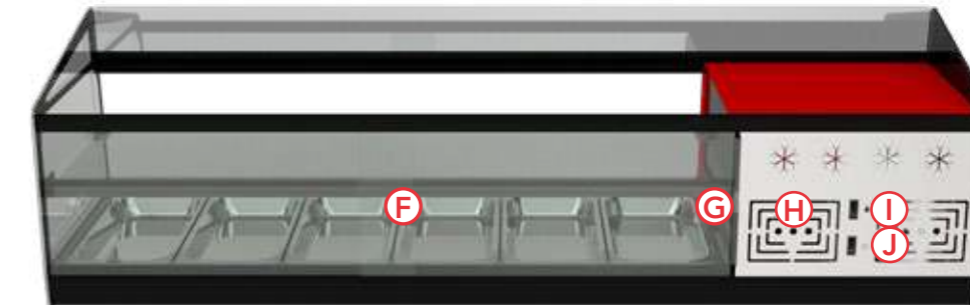
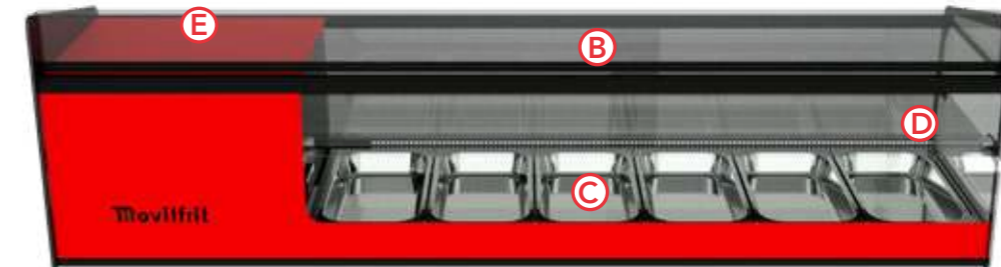

- ✓ DOBLE ACRISTALAMIENTO DE SEGURIDAD.
- ✓ MEJOR ESTABILIDAD Y AISLAMIENTO DE TEMPERATURA.
- ✓ MENOR CONSUMO.

ACCESORIOS NO INCLUIDOS / ACCESSORIES NOT INCLUDED / ACCESSOIRES NON INCLUS

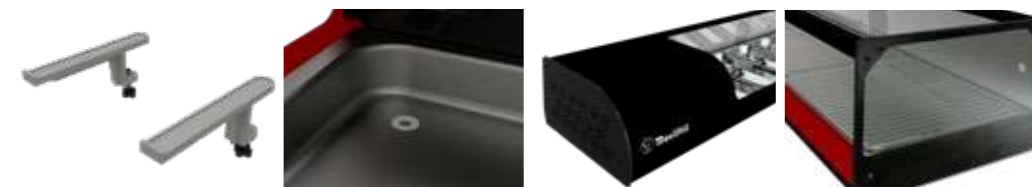

ACCESORIOS NO INCLUIDOS	ACCESSORIES NOT INCLUDED	ACCESSOIRES NON INCLUS
Juego soportes Bracket set Kit de fixation	Kit desagüe Drain kit Kit de vidange	Motor lado contrario Motor on opposite side Moteur côté opposé
REF. € x 2	REF. € x 1	REF. € x 1
916872 <b>111,21</b>	905415 <b>65,00</b>	300 <b>115,39</b>
		Parrillas inox cuba plana SS grills flat bowl Grilles en acier inox. Cuvette plate
		REF. € x 1
		918361 <b>36,00</b>

CUB TOP

- +2°C/+6°C
- 230V
- Led
- Bandejas  
Trays  
Plateaux
- Colores  
Colours  
Couleurs
- Personalizable  
Customisable  
Personnalisable

(+34) 936 358 758

(+34) 608 299 107

pedidos@movilfritofficial.com

www.movilfritofficial.com



DISPLAY CASES WITH FLAT CRYSTAL

Built in AISI304 stainless steel

- B** High quality led
- C** Trays included
- D** Cuba without angles
- E** 34 cm to support plates
- F** Sliding doors
- G** Adjustable manual thermostat
- I** Led switch
- J** General switch
- L** Drain

VITRINE À VITRES PLATS

Construit en acier inoxydable AISI304

- B** Led de haute qualité
- C** Plateaux inclus
- D** Cuba sans angles
- E** 34 cm pour support planchas
- F** Portes coulissantes
- G** Thermostat manuel réglable
- I** Interrupteur Led
- J** Interrupteur général
- L** Vidanger



CUB 4

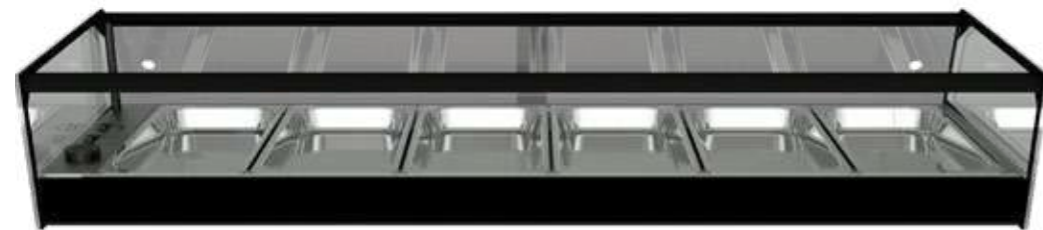

CUB 6



VITRINA CON CRISTAL PLANO

Construida en acero inoxidable AISI304

- B** Led alta calidad
- C** Bandejas incluidas
- D** Cuba sin ángulos
- E** 34 cm para apoyar platos
- F** Puertas correderas
- G** Termostato manual regulable
- I** Interruptor Led
- J** Interruptor general
- L** Desagüe

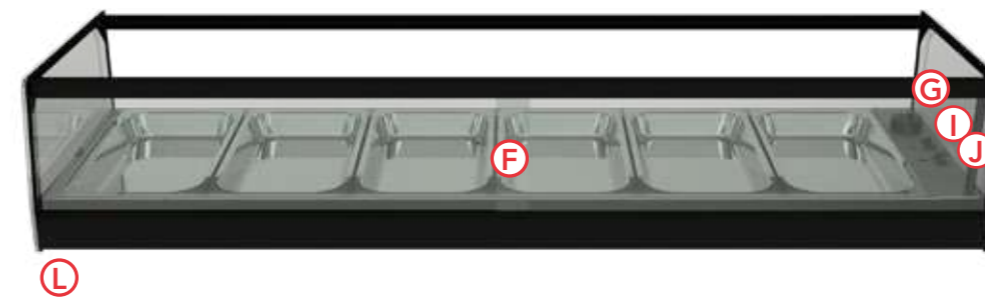

- ✓ DOBLE ACRISTALAMIENTO DE SEGURIDAD.
- ✓ MEJOR ESTABILIDAD Y AISLAMIENTO DE TEMPERATURA.
- ✓ MENOR CONSUMO.

CUB CALENTADOR

- +90°C
- 230V
- Led
- Bandejas  
Trays  
Plateaux
- Personalizable  
Customisable  
Personnalisable

ACCESORIOS NO INCLUIDOS

ACCESORIES NOT INCLUDED

ACCESSOIRES NON INCLUS



Juego soportes Bracket set Kit de fixation	
REF.	€ x 2
916872	111,21

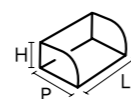

MOD.		W	V	L x P x H (mm)	KG	REF.	€
CUB 4 CALENTADOR BAÑO MARÍA	4 x GN1/3 x 40	1000	230	807 x 390 x 252	20	807096	890
CUB 6 CALENTADOR BAÑO MARÍA	6 x GN1/3 x 40			1146 x 390 x 252	28	807097	970

NEUTRAL DISPLAY CASES

Built in AISI304 stainless steel

- A** 34 cm to support plates
- B** Sliding doors

VITRINE NEUTRE

Construit en acier inoxydable AISI304

- A** 34 cm pour support planchas
- B** Portes coulissantes



EXPOSITOR NEUTRO 1 PISO PLANO

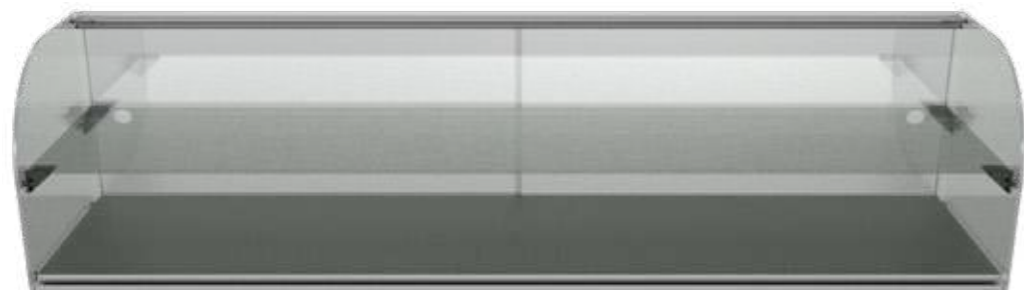

EXPOSITOR NEUTRO 2 PISOS CURVADO

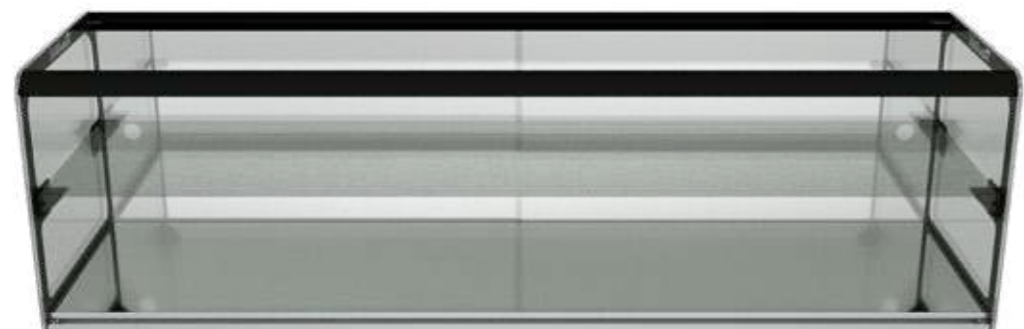

EXPOSITOR NEUTRO 2 PISOS PLANO

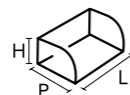

MOD.				L x P x H (mm)	KG	REF.	€
EXPOSITOR NEUTRO PLANO DESMONTADO	FLAT TO MOUNT	PLAT À INSTALLER	1	1010 x 300 x 200	6	306541	240
			2	1010 x 300 x 300	7	306542	352
EXPOSITOR NEUTRO PLANO	FLAT	PLAT	1	1010 x 300 x 200	6	306551	271
EXPOSITOR NEUTRO CURVADO	CURVE	CURBÉE	1	1010 x 300 x 200	6	306550	295
EXPOSITOR NEUTRO PLANO	FLAT	PLAT	2	1010 x 300 x 300	7	306553	389
EXPOSITOR NEUTRO CURVADO	CURVE	CURVÉ	2	1010 x 300 x 300	7	306552	383

VITRINA EXPOSITOR NEUTRO

Construida en acero inoxidable AISI304

- A** 34 cm para apoyar platos
- B** Puertas correderas



EXPOSITOR 4 NEUTRO 1 PISO

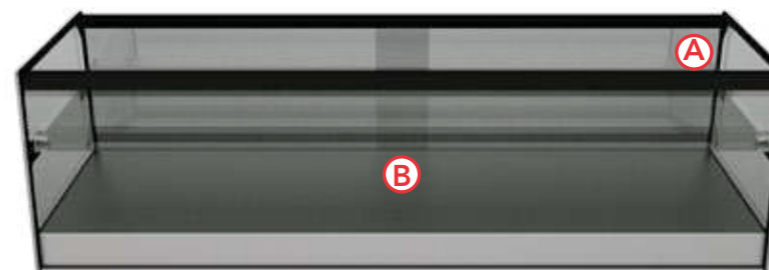

EXPOSITOR 6 NEUTRO 2 PISOS

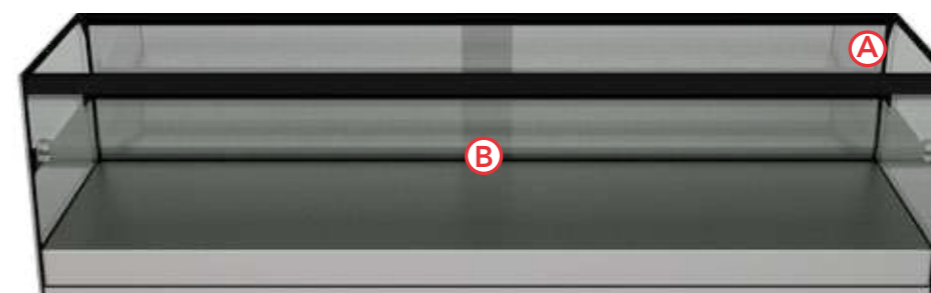

EXPOSITOR 8 NEUTRO 2 PISOS

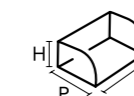

MOD.				L x P x H (mm)	KG	REF.	€
EXPOSITOR 4 NEUTRO	1	752 x 390 x 224	15	307026	350		
EXPOSITOR 6 NEUTRO	1	1092 x 390 x 224	23	307027	469		
EXPOSITOR 8 NEUTRO	1	1432 x 390 x 224	30	307028	604		
EXPOSITOR 4 NEUTRO	2	752 x 390 x 330	28	307029	450		
EXPOSITOR 6 NEUTRO	2	1092 x 390 x 330	36	307030	522		
EXPOSITOR 8 NEUTRO	2	1432 x 390 x 330	32	307031	598		

EXPOSITOR



Personalizable  
Customisable  
Personnalisable

(+34) 936 358 758

(+34) 608 299 107

pedidos@movilfritofficial.com

www.movilfritofficial.com



COUNTERTOP

Built in AISI304 stainless steel

- (A) Adjustable digital thermostat
- (B) Insulation 30 mm
- (C) General switch
- (D) Aisi304 stainless steel flat tray
- (E) Exterior finishing in AISI304 stainless steel perimeter tube
- (F) Motor

BASE FROIDE

Construit en acier inoxydable AISI304

- (A) Thermostat digital réglable
- (B) Isolation 30 mm
- (C) Interrupteur général
- (D) Plateau plat en acier inoxydable AISI304
- (E) Finition extérieure en tube périmétrique en acier inoxydable AISI304
- (F) Moteur



ENCIMERA 1000



ENCIMERA 1500



ENCIMERA 2000

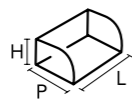

MOD.	V	L x P x H (mm)	KG	REF.	€
ENCIMERA 1000 SIN GRUPO MOTOR	230	1000 x 400 x 50	5	306561	<b>1041</b>
ENCIMERA 1500 SIN GRUPO MOTOR		1500 x 400 x 50	7	306562	<b>1203</b>
ENCIMERA 2000 SIN GRUPO MOTOR		2000 x 450 x 50	9	306563	<b>1368</b>



ENCIMERAS

Construida en acero inoxidable AISI304

- (A) Termostato digital regulable
- (B) Aislamiento 30 mm
- (C) Interruptor general
- (D) Bandeja plana acero inoxidable AISI304
- (E) Acabado exterior en tubo perimetral de acero inoxidable AISI304
- (F) Grupo motor



ENCIMERA 1000



ENCIMERA 1500

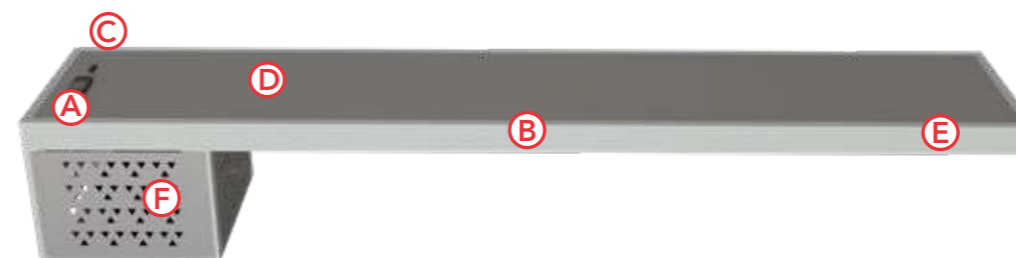

ENCIMERA 2000

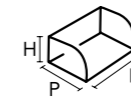

MOD.	W	V	L x P x H (mm)	KG	REF.	€
ENCIMERA 1000 CON GRUPO MOTOR	160	230	1000 x 400 x 300	10	306564	<b>1575</b>
ENCIMERA 1500 CON GRUPO MOTOR			1500 x 400 x 330	12	306565	<b>1650</b>
ENCIMERA 2000 CON GRUPO MOTOR			2000 x 400 x 330	14	306566	<b>1800</b>

ENCIMERA



(+34) 936 358 758

(+34) 608 299 107

pedidos@movilfritofficial.com

www.movilfritofficial.com



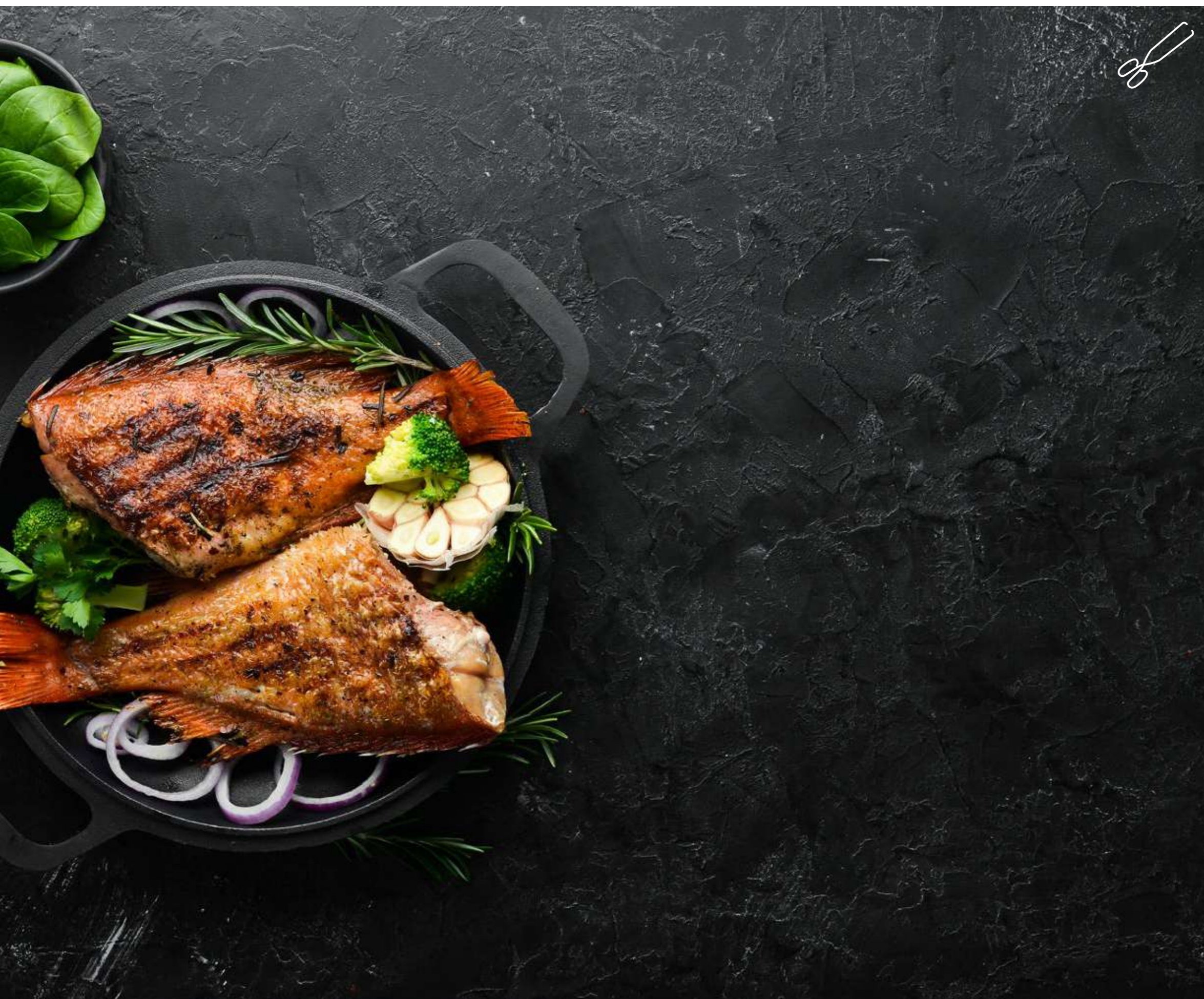

# BRASA

74-75 HORNOS DE AIRE

76-77 HORNOS

78-79 BARBACOA

# CHARCOAL

74-75 AIR OVENS

76-77 OVEN

78-79 BARBECUES

# BRAISE

74-75 FOURS D'AIRE

76-77 FOURS

78-79 BARBECUES



OPEN CHARCOAL OVEN  
AIR

Built in AISI304 stainless steel

- (A) Internal firewall
- (B) Stainless grill
- (C) Vertical ventilation
- (E) Removable ash collection drawer
- (H) General switch

FOUR À CHARBON OUVERT  
AIR

Construit en acier inoxydable AISI304

- (A) Pare-feu interne
- (B) Gril inox
- (C) Ventilation verticale
- (E) Tiroir de collecte des cendres amovible
- (H) Interrupteur général



HBA 30



HORNO BRASA ABIERTO  
AIRE

Construida en acero inoxidable AISI304

- (A) Cortafuegos interno
- (B) Parrilla inoxidable
- (D) Ventilación vertical
- (E) Cajón recoge-cenizas extraíble
- (H) Interruptor general



HBA 60

NEW

- 230V
- 250 - 350°C
- Personalizable  
Customisable  
Personnalisable



ACCESORIOS INCLUIDOS

ACCESORIES INCLUDED

ACCESSOIRES INCLUS

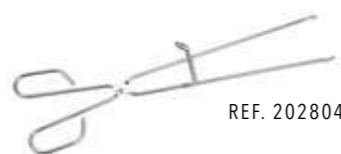

ACCESORIOS NO INCLUIDOS

ACCESORIES NOT INCLUDED

ACCESSOIRES NON INCLUS



Mesa horno  
Oven table  
Table du four

L x P x H (mm)	REF.	€ x 1
920x810x730	202800	1480



Sombrero  
Hat  
Chapeau

Ø x H (mm)	REF.	€ x 1
245 x 170	202801	265



Cortafuegos externo  
External firewall  
Coupe-feu externe

Ø x H (mm)	REF.	€ x 1
255 x 215	202802	405



Regulador de tiro externo  
External draught regulator  
Régulateur de tirage externe

Ø x H (mm)	REF.	€ x 1
158 x 170	202803	298



Parrilla pescado  
Fish grill  
Gril à poisson

L x P x H (mm)	REF.	€ x 1
300 x 350 x 125	202805	82



Parrilla besuguera  
Bream grill  
Grillade de daurade

L x P x H (mm)	REF.	€ x 1
540 x 135 x 125	202806	58

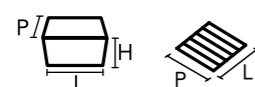

MOD.	Producción Production Production (kg/h)	kW	V	L x P x H (mm)	L x P x H (mm)	Consumo x día Consumption x day Consommation x jour (kg)	Autonomía Autonomy Autonomie (h)	Carga carbón Charcoal charge Chargement carbone (kg)	KG	REF.	€
HBA-30	70	5,5	230	810 x 630 x 1250	600 x 470	10 - 12	9	3	80	202110	4184
HBA-60	90								100	202109	5350

(+34) 936 358 758

(+34) 608 299 107

pedidos@movilfritofficial.com

www.movilfritofficial.com

### COMPACT OVEN

Internally built in cast steel  
Completely isolated

- (A) Internal firewall
- (B) Grooved grill, included (HBR6)
- (C) Rod grill, included (HBR6, HBR4)
- (E) Removable ash collection drawer
- (F) Regulable non-slip legs
- (G) Integrated thermometer up to 500 °C

### FOUR COMPACT

Construit à l'intérieur en acier moulé  
Complètement isolé

- (A) Pare-feu interne
- (B) Grille rainurée inclus (HBR6)
- (C) Gril à tige inclus (HBR6, HBR4)
- (E) Tiroir de collecte des cendres amovible
- (F) Regulable pieds antidérapant
- (G) Thermomètre intégré jusqu'à 500 °C



### HORNO COMPACTO

Construido interiormente en acero fundido  
Completamente aislado

- (A) Cortafuegos interno
- (B) Parrilla acanalada incluida (HBR6)
- (C) Parrilla de varilla incluida (HBR6, HBR4)
- (E) Cajón recoge-cenizas extraíble
- (F) Patas antideslizantes regulables
- (G) Termómetro integrado hasta 500 °C



HBR 4



HBR 6 PRO



HBR 4

HBR 6

- 250 - 350°C
- Personalizable  
Customisable  
Personnalisable

#### ACCESORIOS INCLUIDOS

#### ACCESORIES INCLUDED

#### ACCESSOIRES INCLUS

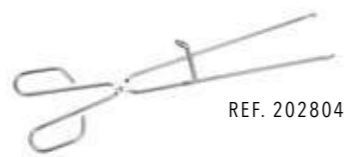

REF. 202804



REF. 202807

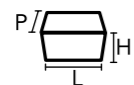

MOD.	Producción Production Production (kg/h)	⚡ kW	L x P x H (mm)	Consumo x día Consumption x day Consommation x jour (kg)	Autonomía Autonomy Autonomie (h)	Carga carbón Charcoal charge Chargement carbone (kg)	KG	REF.	€
HBR-4	70	4,5	680 x 535 x 670	10 - 12	8	3	117	202100	5420
HBR-6	90	5,5	900 x 790 x 900	12 - 16	8	4	244	202102	6719
HBR-4 PRO	70	4,5	680 x 535 x 670	10 - 12	8	3	117	202103	5200
HBR-6 PRO	90	5,5	900 x 790 x 900	12 - 16	8	4	244	202105	6508

#### ACCESORIOS NO INCLUIDOS

#### ACCESORIES NOT INCLUDED

#### ACCESSOIRES NON INCLUS



Mesa horno  
Oven table  
Table du four

L x P x H (mm)	REF.	€ x 1
920x810x730	202800	1480



Sombrero  
Hat  
Chapeau

Ø x H (mm)	REF.	€ x 1
245 x 170	202801	265



Cortafuegos externo  
External firewall  
Coupe-feu externe

Ø x H (mm)	REF.	€ x 1
255 x 215	202802	405



Regulador de tiro externo  
External draught regulator  
Régulateur de tirage externe

Ø x H (mm)	REF.	€ x 1
158 x 170	202803	298



Parrilla pescado  
Fish grill  
Gril à poisson

L x P x H (mm)	REF.	€ x 1
300 x 350 x 125	202805	82



Parrilla besuguera  
Bream grill  
Grillade de daurade

L x P x H (mm)	REF.	€ x 1
540 x 135 x 125	202806	58



GRILLED BARBECUE

- B** Stainless grill  
3 Grill heights
- E** Removable ash collection drawer

BARBECUE GRILLÉ

- B** Gril inox.  
3 Hauteurs de gril
- E** Tiroir de collecte des cendres amovible



BARBACOA DE BRASA

- B** Parrilla inoxidable  
3 Alturas de parrilla
- E** Cajón recoge-cenizas extraíble

BM

NEW



BM 50



BM 80

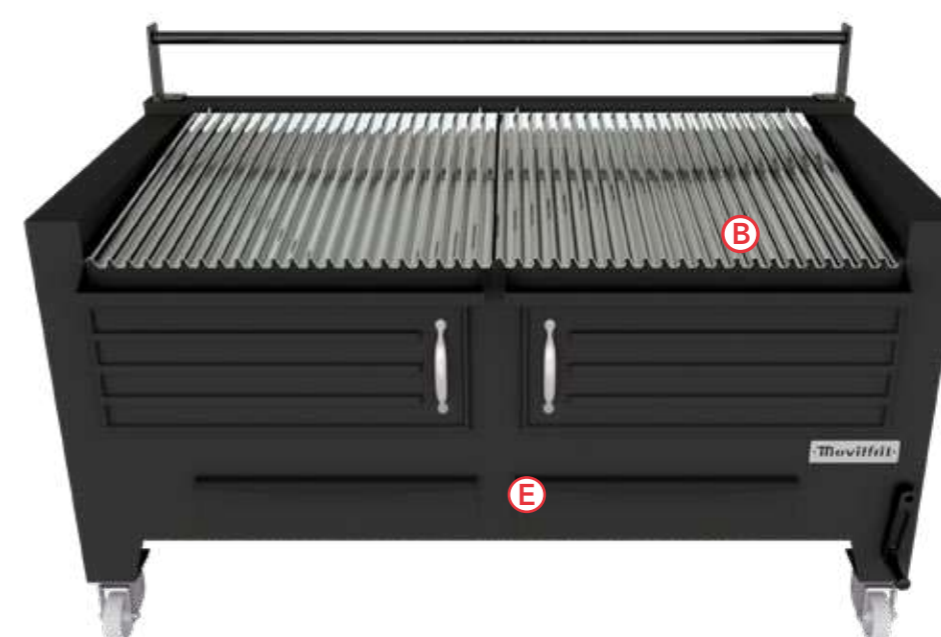

BM 160

Personalizable  
Customisable  
Personnalisable



ACCESORIOS INCLUIDOS

ACCESORIES INCLUDED

ACCESSOIRES INCLUS

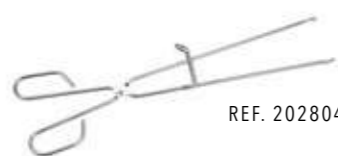

REF. 202804



REF. 202807

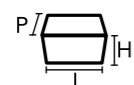

MOD.	Producción Production Production (kg/h)	⚡ kW	L x P x H (mm)	Consumo x día Consumption x day Consommation x jour (kg)	Autonomía Autonomy Autonomie (h)	Carga carbón Charcoal charge Chargement carbone (kg)	KG	REF.	€
BM-50	90	5,5	800 x 820 x 930	12 - 16	8	4	200	202119	<b>3825</b>
BM-80	90	5,5	800 x 820 x 930	12 - 16	8	4	240	202120	<b>7823</b>
BM-160	180	11	1455 x 820 x 930	24 - 32	8	8	410	202121	<b>9008</b>

ACCESORIOS NO INCLUIDOS

ACCESORIES NOT INCLUDED

ACCESSOIRES NON INCLUS



Plancha lisa  
Plaque lisse  
Smooth griddle



Parrilla pescado  
Fish grill  
Gril à poisson



Parrilla besuguera  
Bream grill  
Grillade de daurade

L x P (mm)	REF.	€ x 1	L x P x H (mm)	REF.	€ x 1	L x P x H (mm)	REF.	€ x 1
585 x 435	202821	<b>210</b>	300 x 350 x 125	202805	<b>82</b>	540 x 135 x 125	202806	<b>58</b>

(+34) 936 358 758

(+34) 608 299 107

pedidos@movilfritofficial.com

www.movilfritofficial.com





# MODULAR

82-85 LÍNEA MODULAR  
630

# MODULAR

82-85 MODULAR LINE  
630

# MODULAIRE

82-85 LIGNE MODULAIRE  
630



# MODULAR 630

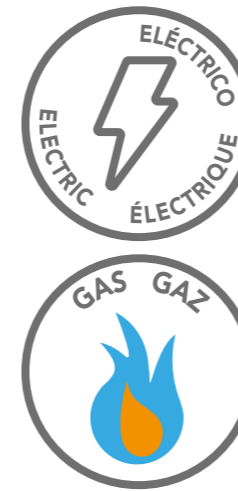

FRY TOP- GAS / ELÉCTRICOS (40 /80)  
FRY TOP- GAS / ELECTRICS (40 /80)  
FRY TOP- GAZ / ÉLECTRIQUES (40 /80)

CUECEPASTAS- GAS / ELÉCTRICOS (40 /80)  
FRY TOP- GAS / ELECTRICS (40 /80)  
FRY TOP- GAZ / ÉLECTRIQUES (40 /80)



COCINAS GAS (2 / 4 FUEGOS)  
GAS KITCHEN (2 / 4 FIRES)  
CUISINIÈRES (2 / 4 FEUX)

FREIDORAS- GAS / ELÉCTRICAS  
PASTA COOKER- GAS / ELECTRICS  
CUISEUR DE PÂTES- GAZ / ÉLECTRIQUES



230V



+2°C/+6°C



Personalizable  
Customisable  
Personnalisable



FEM 10

CPEM 40

BGM 40

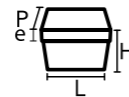
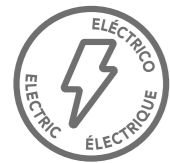

MOD.				⚡ kW	V	L x P x H (mm)	e (mm)	🍹 L	📦 KG	REF.	€
FEM-10	FREIDORA	FRYER	FRITEUSE	9	230	400 x 630 x 300	-	10	10	606300	1453
FEM-10+10				9+9	230	700 x 630 x 300	-	10+10	18	606301	2565
FTEM-40	FRY TOP	FRY TOP	FRY TOP	5	400	400 x 630 x 300	12	-	15	606331	940
FTEM-80				10	400	800 x 630 x 300	12	-	30	606333	1368
CPEM-40	CUECEPASTAS	PASTA COOKER	CUISEUR DE PÂTES	6	400	400 x 630 x 300	-	10	10	606350	1368
MFE-40	MANTENEDOR FRITOS	FRIED FOOD MAINTAINER	MAINTENEUR DE FRITURES	1	230	400 x 630 x 300	-	-	10	606360	769

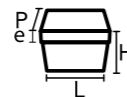

MOD.				⚡ kW	L x P x H (mm)	e (mm)	🍹 L	🔥 kcal	📦 KG	REF.	€
FGM-10	FREIDORA	FRYER	FRITEUSE	10	400 x 630 x 300	-	10	6076	12	606302	1624
FGM-10+10				10+10	700 x 630 x 300	-	10+10	12152	20	606303	2736
FTGM-40				7	400 x 630 x 300	12	-	6076	22	606330	1026
FTGM-40 CROMO	FRY TOP	FRY TOP	FRY TOP						25	606334	1385
FTGM-80				14	800 x 630 x 300	12	-	12152	50	606335	1505
FTGM-80 CROMO									44	606332	2034
CGM-2	COCINA 2 FUEGOS	KITCHEN 2 FIRES	CUISINIÈR 2 FEUX	10	400 x 630 x 300	-	-	8680	12	606320	855
CGM-4	COCINA 4 FUEGOS	KITCHEN 4 FIRES	CUISINIÈR 4 FEUX	20	600 x 630 x 300	-	-	17360	22	606321	1368
BGM-40	BARBARCOA	BARBACUE	BARBECUE	7	400 x 630 x 300	-	-	6076	15	606340	1350
BGM-80				14	800 x 630 x 300	-	-	12152	30	606341	1898
CPGM-40	CUECEPASTAS	PASTA COOKER	CUISEUR DE PÂTES	7	400 x 630 x 300	-	10	6076	10	606351	1453



FTEM 80



CGM 4



FGM 10+10

# MODULAR 630



230V



+2°C/+6°C



Personalizable  
Customisable  
Personnalisable

(+34) 936 358 758

(+34) 608 299 107

pedidos@movilfritofficial.com

www.movilfritofficial.com





# PLANCHAS

88-89 ELÉCTRICAS

90-91 GAS

# GRIDDLES

88-89 ELECTRIC

90-91 GAS

# PLANCHA

88-89 ÉLECTRIQUE

90-91 GAZ



**ELECTRIC GRIDDLES**

Built in AISI304 stainless steel

- A** Laminated iron plate
- B** Grease collector tray
- C** Non-slip legs
- D** Adjustable working thermostat
- E** General switch

**PLANCHA ÉLECTRIQUE**

Construit en acier inoxydable AISI304

- A** Plaque en fer laminé
- B** Plateau collecteur de graisses
- C** Pieds antidérapants
- D** Thermostat de travail réglable
- E** Interrupteur général



PEM 40

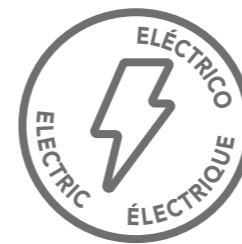

**PLANCHAS ELÉCTRICAS**

Construida en acero inoxidable AISI304

- A** Placa laminada de hierro
- B** Bandeja recogedor de grasa
- C** Patas antideslizantes
- D** Termostato trabajo regulable
- E** Interruptor general



PEM 60

**PEM**

- 230V
- +300°C
- Personalizable  
Customisable  
Personnalisable

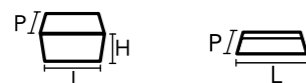

MOD.	kW	L x P x H (mm)	L x P (mm)	KG	REF.	€
PEM-40	2,5	400 x 500 x 200	380 x 480	15	203023	<b>309</b>
PEM-60	5	600 x 500 x 200	580 x 480	22	203024	<b>418</b>



ECONOMIC GAS GRIDDLES

Built in AISI304 stainless steel

- (A) Laminated iron plate
- (B) Grease collector tray
- (C) Non-slip legs
- (D) Gas valve adjustment
- (F) Piezo electric

PLANCHA GAZ ÉCONOMIQUE

Construit en acier inoxydable AISI304

- (A) Plaque en fer laminé
- (B) Plateau collecteur de graisses
- (C) Pieds antidérapants
- (D) Réglage de la soupape à gaz
- (F) Piezo électrique



PLANCHAS DE GAS ECONÓMICAS

Construida en acero inoxidable AISI304

- (A) Placa laminada de hierro
- (B) Bandeja recogedor de grasa
- (C) Patas antideslizantes
- (D) Regulación válvula de gas
- (F) Piezo eléctrico



PGM 40



PGM 60



PGM 80

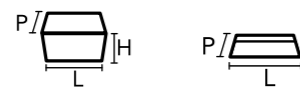

MOD.	kW	kcal / h	L x P x H (mm)	L x P (mm)	Valvulas / Valves / Soupapes	KG	REF.	€
PGM 40	3	5040	400 x 500 x 200	380 x 480	1	12	203047	304
PGM 60	6	10080	600 x 500 x 200	580 x 480	2	23	203048	410
PGM 80	6	10080	800 x 500 x 200	780 x 480	2	34	203049	549

PGM

- Gas / Gaz
- Personalizable / Customisable / Personnalisable



(+34) 936 358 758

(+34) 608 299 107

pedidos@movilfritofficial.com

www.movilfritofficial.com

RECTIFIED GAS GRIDDLES

Built in AISI304 stainless steel

- A** Laminated iron plate
- B** Grease collector tray
- C** Non-slip legs
- D** Gas valve adjustment
- G** Gas intake

PLANCHA GAZ RECTIFIÉ

Construit en acier inoxydable AISI304

- A** Plaque en fer laminé
- B** Plateau collecteur de graisses
- C** Pieds antidérapants
- D** Réglage de la soupape à gaz
- G** Entrée de gaz



PLANCHA GAS RECTIFICADAS

Construida en acero inoxidable AISI304

- A** Placa laminada de hierro
- B** Bandeja recogedor de grasa
- C** Patas antideslizantes
- D** Regulación válvula de gas
- G** Entrada de gas



PGR 45

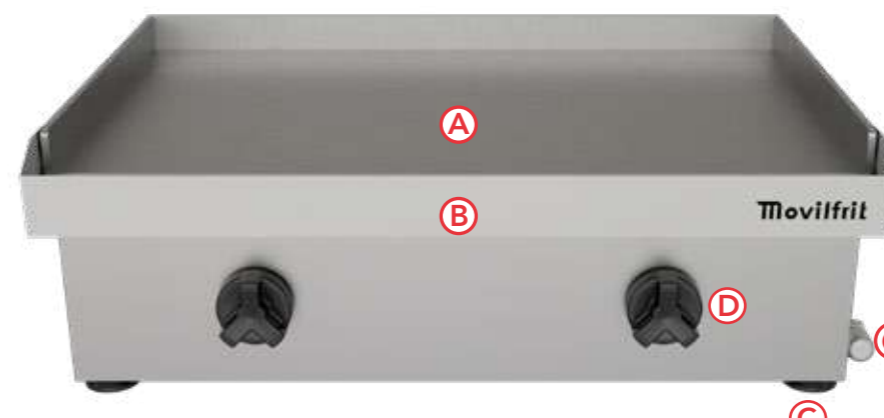

PGR 65

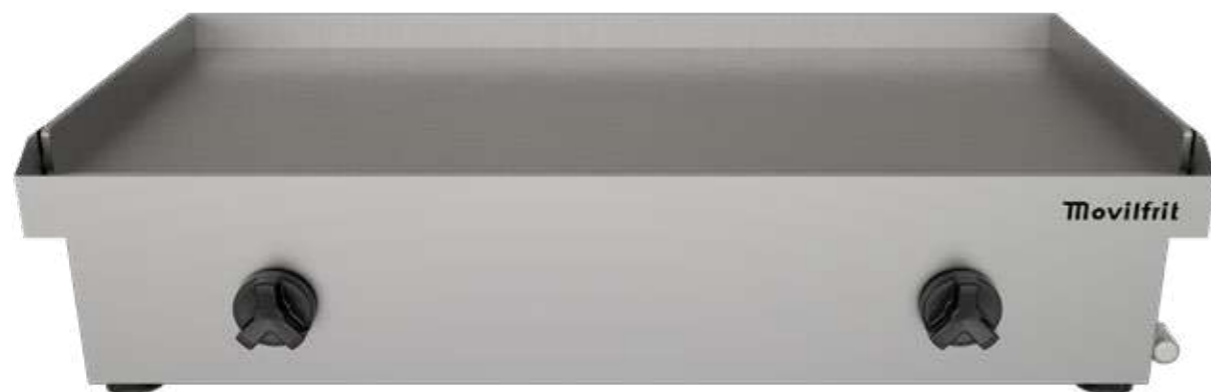

PGR 85

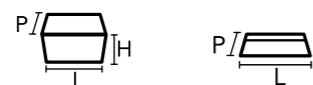

MOD.	kW	kcal / h	L x P x H (mm)	L x P (mm)	Valvulas / Valves / Soupapes	KG	REF.	€
PGR-45	4,5	4950	465 x 430 x 260	444 x 395	1	15	203053	<b>824</b>
PGR-65	7	7701	665 x 430 x 260	644 x 395	2	27	203054	<b>835</b>
PGR-85	9	9901	865 x 430 x 260	844 x 395	2	37	203055	<b>1095</b>

**PGR**

- Gas / Gaz
- Personalizable / Customisable / Personnalisable



(+34) 936 358 758

(+34) 608 299 107

pedidos@movilfritofficial.com

www.movilfritofficial.com



### CHROME GAS GRIDDLES

Built in AISI304 stainless steel

- A** Chrome plate
- B** Grease collector tray
- C** Non-slip legs
- D** Gas valve adjustment
- G** Gas intake

### PLANCHA GAZ CHROME

Construit en acier inoxydable AISI304

- A** Plaque chrome
- B** Plateau collecteur de graisses
- C** Pieds antidérapants
- D** Réglage de la soupape à gaz
- G** Entrée de gaz



### PLANCHA A GAS CROMO

Construida en acero inoxidable AISI304

- A** Placa cromada
- B** Bandeja recogedor de grasa
- C** Patas antideslizantes
- D** Regulación válvula de gas
- G** Entrada de gas



PGC 45

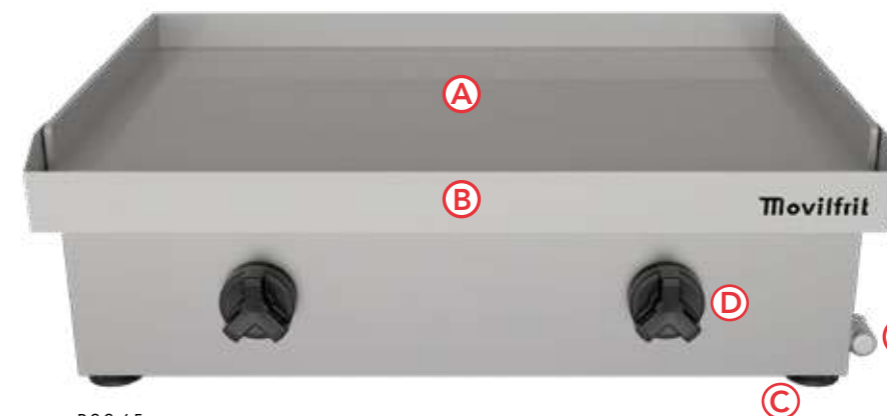

PGC 65

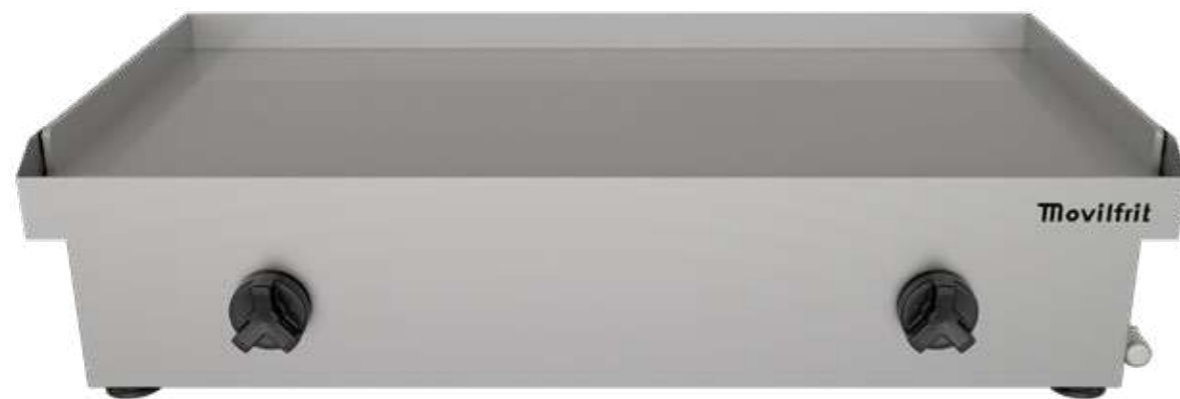

PGC 85

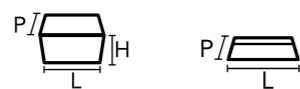

MOD.	kW	kcal / h	L x P x H (mm)	L x P (mm)	Valvulas / Valves / Soupapes	KG	REF.	€
PGC 45	4,5	4950	400 x 430 x 220	444 x 395	1	19	203062	1265
PGC 65	7	7701	600 x 430 x 220	644 x 395	2	30	203063	1465
PGC 85	9	9901	800 x 430 x 200	844 x 395	2	34	203064	1783

# PGC



Gas  
Gaz



Personalizable  
Customisable  
Personnalisable



(+34) 936 358 758

(+34) 608 299 107

pedidos@movilfritofficial.com

www.movilfritofficial.com





# COCINAS

98-99 GAS

# KITCHEN

98-99 GAS

# CUISINIÈRES

98-99 GAZ



GAS KITCHENS

Built in AISI304 stainless steel

- A** Removable fireplace to easily clean and maintenance
- B** Removable grill
- C** Gas valve adjustment

CUISINIÈRES À GAZ

Construit en acier inoxydable AISI304

- A** Foyer amovible pour un nettoyage et une maintenance faciles
- B** Gril amovible
- C** Réglage de la soupape à gaz



COCINAS A GAS

Construida en acero inoxidable AISI304

- A** Fogón extraíble para facilitar su limpieza y mantenimiento
- B** Parrilla desmontable
- C** Regulación válvula gas



ECOM 1 FUEGO



ECOM 2 FUEGOS



ECOM 3 FUEGOS



ECOM 4 FUEGOS

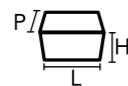

MOD.	kW	kcal / h	L x P x H (mm)	Valvulas Valves Soupapes	KG	REF.	€
ECOM 1 FUEGO	6	10080	450 x 490 x 200	1	20	203098	<b>449</b>
ECOM 2 FUEGOS	12	20160	800 x 490 x 200	2	24	203099	<b>818</b>
ECOM 3 FUEGOS	18	30240	1200 x 490 x 200	3	36	203100	<b>1221</b>
ECOM 4 FUEGOS	24	40320	800 x 840 x 200	4	50	203101	<b>1391</b>

**ECOM**



Gas  
Gaz



Personalizable  
Customisable  
Personnalisable



(+34) 936 358 758

(+34) 608 299 107

pedidos@movilfritofficial.com

www.movilfritofficial.com



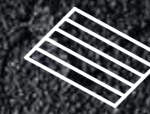

# BARBACOAS

102-103 GAS

# BARBACUE

102-103 GAS

# BARBECUES

102-103 GAZ



BARBACUE WITH SS GRILL

Built in AISI304 stainless steel

- A** Rease collector tray
- B** Elevation system
- C** Waste collecting tray
- D** Gas valve adjustment
- E** Ribbed grill

BARBECUE AVEC GRIL EN ACIER INOX

Construit en acier inoxydable AISI304

- A** Plateau collecteur de graisses
- B** Système d'élevation
- C** Bac de récupération des déchets
- D** Réglage de la soupape à gaz
- E** Gril côtelé



BARBACOA CON PARRILLA INOX

Construida en acero inoxidable AISI304

- A** Bandeja recogedor grasa
- B** Sistema de elevación
- C** Bandeja recogedor residuos
- D** Regulación válvula gas
- E** Parrilla acanalada



BM 35



BM 60

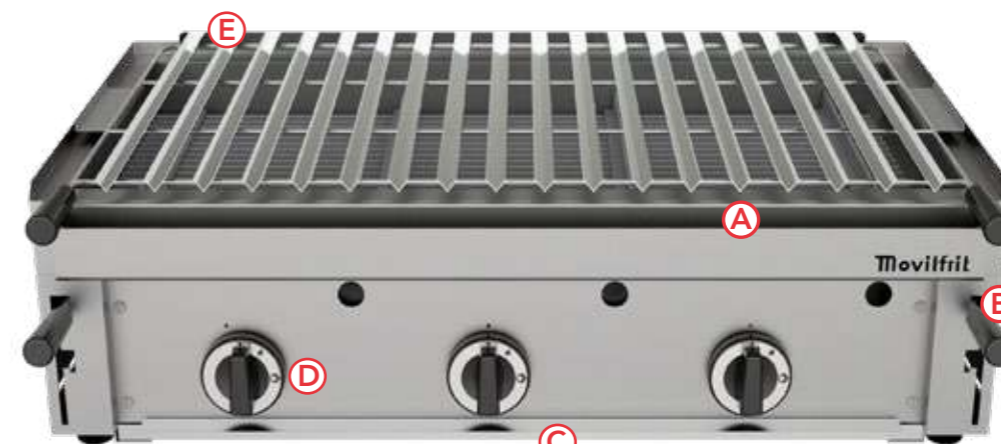

BM 90

- Gas  
Gaz
- Personalizable  
Customisable  
Personnalisable

ACCESORIOS INCLUIDOS

ACCESORIES INCLUDED

ACCESSOIRES INCLUS



BOLSA PIEDRA VOLCÁNICA  
3 Kg

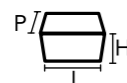

MOD.	kW	kcal / h	L x P x H (mm)	Valvulas Valves Soupapes	KG	REF.	€
BM-35	6,8	11424	370 x 600 x 260	1	25	203095	<b>791</b>
BM-60	13,6	22848	600 x 600 x 260	2	39	203096	<b>1209</b>
BM-90	20.4	34272	900 x 600 x 260	3	53	203097	<b>1706</b>

(+34) 936 358 758

(+34) 608 299 107

pedidos@movilfritofficial.com

www.movilfritofficial.com





# TOSTADORES

106-107 RESISTENCIA

108-109 CINTA

# TOASTERS

106-107 RESISTANCE

108-109 BELT

# GRILLE PAIN

106-107 RÉSISTANCE

108-109 BANDE



RESISTANCE TOASTER

Built in AISI304 stainless steel

- A** Timer
- B** Resistors switches
- C** Waste collecting tray
- D** Armored resistance

GRILLE-PAIN À RÉSISTANCE

Construit en acier inoxydable AISI304

- A** Minuteur
- B** Commutateurs de résistances
- C** Bac de récupération des déchets
- D** Résistance blindée

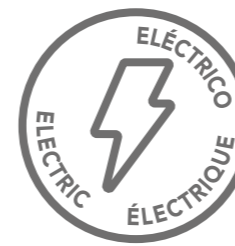

TOSTADOR DE RESISTENCIA

Construida en acero inoxidable AISI304

- A** Temporizador
- B** Interruptores resistencias
- C** Bandeja recogedor residuos
- D** Resistencia blindada



TM1T



TM1



TM2T

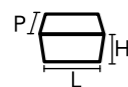

MOD.	kW	L x P x H (mm)	(min)	KG	REF.	€
TM1	2,4	535 x 270 x 280	-	7	440030	<b>248</b>
TM1T	2,4	535 x 270 x 280	✓	7	440031	<b>264</b>
TM2	3,6	535 x 270 x 370	-	9	440032	<b>304</b>
TM2T	3,6	535 x 270 x 370	✓	9	440033	<b>319</b>

TM



230V



Personalizable  
Customisable  
Personnalisable



(+34) 936 358 758

(+34) 608 299 107

pedidos@movilfritofficial.com

www.movilfritofficial.com

BELT TOASTER

Built in AISI304 stainless steel

- A** Belt speed regulator
- B** Resistors switches
- C** General switch

GRILLE-PAIN À BANDE

Construit en acier inoxydable AISI304

- A** Régulateur de vitesse de courroie
- B** Commutateurs de résistances
- C** Interrupteur général



TCM 210

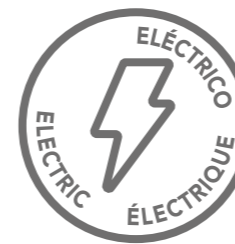

TOSTADOR DE CINTA

Construida en acero inoxidable AISI304

- A** Regulador velocidad de la cinta
- B** Interruptor resistencias
- C** Interruptor general



TCM 375

TMC



230V



Personalizable  
Customisable  
Personnalisable

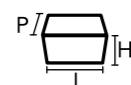

MOD.	kW	L x P x H (mm)	(min)	KG	REF.	€
TCM-210	3	885 x 450 x 320	210 x 75 (h)	25	440034	<b>1581</b>
TCM-375	4	885 x 615 x 320	375 x 75 (h)	30	440035	<b>1737</b>

(+34) 936 358 758

(+34) 608 299 107

pedidos@movilfritofficial.com

www.movilfritofficial.com







# MICROONDAS

112-113 ECONÓMICO

# MICROWAVES

112-113 ECONOMIC

# MICRO-ONDES

112-113 ÉCONOMIQUE



MICROWAVE ECONOMIC OVEN

Built in AISI304 stainless steel

- A** Digital screen
- B** Menu and time regulator
- C** Power regulator
- D** Grill included

FOUR MICRO-ONDES ÉCONOMIQUE

Construit en acier inoxydable AISI304

- A** Écran numérique
- B** Régulateur de temps et menu
- C** Régulateur de puissance
- D** Gril incorporé

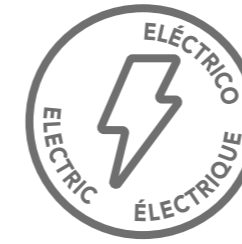

MICROONDAS ECONÓMICO

Construida en acero inoxidable AISI304

- A** Pantalla digital
- B** Regulador de tiempo y menú
- C** Regulador de potencia
- D** Gril incorporado



900 INOX DIGITAL



900 INOX MANUAL



900 INOX

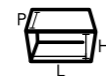
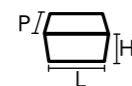

MOD.	Total kW	Grill kW	L x P x H (mm)	L x P x H (mm)	(L)	(KG)	REF.	€
900 INOX MANUAL	1+0,9	0,9	483 x 398 x 281	315 x 360 x 195	23	15,5	402026	<b>272</b>
900 INOX DIGITAL	0,9	-	483 x 398 x 281	315 x 360 x 195			402025	<b>286</b>

(+34) 936 358 758

(+34) 608 299 107

pedidos@movilfritofficial.com

www.movilfritofficial.com







## DOMESTICO

116-117 FREIDORAS

118-119 PLANCHAS

## DOMESTIC

116-117 FRYERS

118-119 GRIDDLES

## DOMESTIQUE

116-117 FRITEUSES

118-119 PLANCHAS



FRYER

Built in AISI304 stainless steel

- (A)** Removable electric head (easy cleaning)
- (B)** Adjustable working thermostat
- (C)** Non-slip legs
- (D)** Evacuate oil tap
- (E)** Elevation system
- (F)** Reinforced stainless steel basket in mesh and rod
- (G)** Waste basket included in model **LUX 5 + FILTRO**

FRITEUSE

Construit en acier inoxydable AISI304

- (A)** Tête électrique amovible (nettoyage facile)
- (B)** Thermostat de travail réglable
- (C)** Pieds antidérapants
- (D)** Robinet pour évacuer l'huile
- (E)** Système d'élévation
- (F)** Panier renforcé en maille et tige en acier inoxydable
- (G)** Filtre à déchets inclu dans le modèle **LUX 5 + FILTRO**



LUX 5



LUX 5



FREIDORA

Construida en acero inoxidable AISI304

- (A)** Cabezal eléctrico extraíble (limpieza fácil)
- (B)** Termostato trabajo regulable
- (C)** Patas antideslizantes
- (D)** Grifo para evacuar aceite
- (E)** Sistema de elevación
- (F)** Cesta reforzada en malla y varilla de acero inox
- (G)** Filtro para residuos incluido en modelo **LUX 5 + FILTRO**



LUX 5

# LUX 5

- Agua-Aceite  
Water-Oil  
Eau-Huile
- 230V
- 200°C
- Grifo  
Tap  
Robinet
- Visor  
Sight Glass  
Voyant
- Elevación  
Elevation  
Élévation
- Personalizable  
Customisable  
Personnalisable

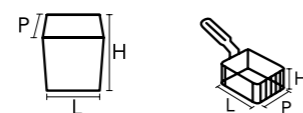

MOD.	kW	V				Total	L x P x H (mm)	L x P x H (mm)	KG	REF.	€
LUX 5	2	230	1	4	5	320 x 270 x 280	Ø 200 x 80	5,5	117054	306	
LUX 5 + FILTRO										117055	350



(+34) 936 358 758

(+34) 608 299 107

pedidos@movilfritofficial.com

www.movilfritofficial.com



**ELECTRIC GRILL**

Built in AISI304 stainless steel

- A** Laminated steel plate 5mm thickness
- B** Removable handles
- C** Adjustable thermostat
- D** Grease collector tray
- E** Special non-stick treatment

**PLANCA ÉLECTRIQUE**

Construit en acier inoxydable AISI304

- A** Plaque en acier laminé de 5mm d'épaisseur
- B** Poignées amovibles
- C** Thermostat réglable
- D** Plateau collecteur de graisses
- E** Traitement spécial antiadhésif

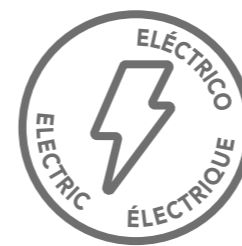

**PLANCHA ELÉCTRIC**

Construida en acero inoxidable AISI304

- A** Placa acero laminado 5mm de grosor
- B** Asas desmontables
- C** Termostato regulable
- D** Bandeja recogedor de grasa
- E** Tratamiento especial antiadherente



PE 500 LUX

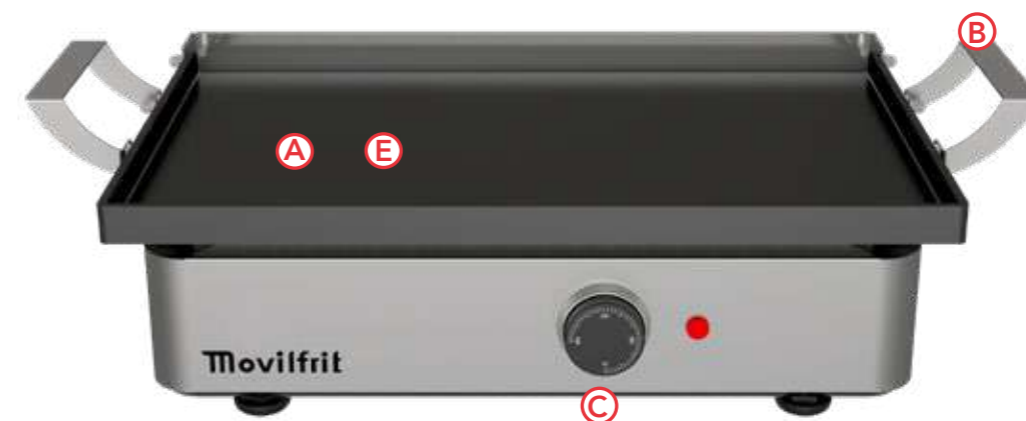

PE 500 LUX



**PE  
500 LUX**

- 230V
- 60°C / 300°C
- Personalizable  
Customisable  
Personnalisable

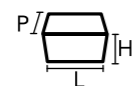

MOD.	kW	V	L x P x H (mm)	L x P (mm)	KG	REF.	€
PE-500 LUX	2,5	230	550 x 315 x 150	450 x 300	11	203030	<b>275</b>

(+34) 936 358 758

(+34) 608 299 107

pedidos@movilfritofficial.com

www.movilfritofficial.com





## RECAMBIOS

- 122 FREIDORAS
- 124 VITRINAS
- 125 PLANCHAS Y BARBACOAS
- 125 BRASA

## SPARE PARTS

- 122 FRYERS
- 124 DISPLAY CASES
- 125 GRIDDLES & BARBECUES
- 125 CHARCOAL

## PIECES DETACHEES

- 122 FRITEUSES
- 124 VITRINES
- 125 PLANCHAS ET BARBECUES
- 125 BRAISE







**FREIDORAS  
FRYERS  
FRITEUSES**

	MOD.	REF.	€
BRIDA GRIFO	5	905035	<b>2,83</b>
	DC 6	907029	<b>299,50</b>
	DC/PRO-8/10	907030	<b>310,80</b>
	DCF-10	907020	<b>310,80</b>
	F 10	907024	<b>180,63</b>
	FA 4	907021	<b>175,25</b>
	FA 6	907022	<b>180,28</b>
	FA 8/9/10 (anterior 2016)	907023	<b>210,32</b>
	FA/PRO-8/9/10 (2016)	907025	<b>170,95</b>
	FAR 10	907008	<b>905,91</b>
	FAR 12/17	907026	<b>1096,43</b>
	FAR 25	907004	<b>1210,17</b>
	FA/PRO-10 MAX 10 400V 9000W	907871	<b>679,81</b>
	PRO MAX 8 400V 6000W	907869	<b>664,75</b>
	PRO MAX 8/10 230V 6000W	907868	<b>629,50</b>
	10 400V	907877	<b>635,82</b>
	10/12/17 230V	907878	<b>610,05</b>
	17/12 400V	907879	<b>705,62</b>
	25	907881	<b>920,87</b>
	35	907882	<b>1225,47</b>
5	907002	<b>131,27</b>	
FA 10 230V MAX	907874	<b>629,50</b>	
FA 10 230V MAX derecho	907872	<b>629,50</b>	
FA-10 400V MAX	907875	<b>679,81</b>	
FA-10 400V MAX derecho	907873	<b>679,81</b>	
CABLE CLAVIJA		901055	<b>10,80</b>
CADENA	25	908054	<b>26,12</b>
	35	908056	<b>29,12</b>
CAJON RESIDUOS	17/25/35	905416	<b>392,00</b>
CAPUCHON FASTON		901060	<b>0,20</b>
CESTA	FA-8/9/10	907044	<b>103,42</b>
	10	907038	<b>114,41</b>
	12/17	907041	<b>149,74</b>
	12/2-17/2	907052	<b>125,15</b>
	25	907042	<b>197,84</b>
	25/2	907033	<b>143,20</b>
	35	907043	<b>300,52</b>
	35/2	907034	<b>254,76</b>
	4	907048	<b>95,31</b>
	5	907035	<b>60,61</b>
6	907047	<b>99,56</b>	
CESTA REFORZADA	4	907039	<b>100,15</b>
	6	907037	<b>102,69</b>
8/10	907045	<b>111,77</b>	
CESTA RESIDUOS	5	901099	<b>29,70</b>
COJINETE EJE ELEVACION	10/12/17	905071	<b>6,22</b>
	5	905058	<b>4,67</b>
CONJUNTO ELEVACION	10/12/17	907155	<b>88,23</b>
	25/35	907104	<b>183,46</b>
CONTACTOR	AF09-30-01-13 3P 230V 4KW	901154	<b>58,72</b>
	AF09-30-01-14 3P 400V 4KW	901155	<b>58,72</b>
	AF09-30-10-13 3P 230V 4KW	901156	<b>58,72</b>
	AF09-30-10-14 3P 400V 4KW	901157	<b>58,72</b>
	AF26-30-00-14 3P 400V 11KW+AUXILIAR	901161	<b>140,12</b>

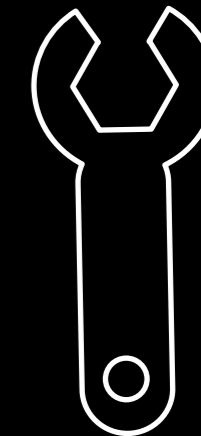
	MOD.	REF.	€
CREMALLERA	F10	905064	<b>31,17</b>
	FH10/12/17	905055	<b>17,05</b>
EJE ELEVACION	10/12/17	905134	<b>8,25</b>
	10/12/17	908104	<b>3,12</b>
EMBRAGUE NYLON	5	908103	<b>3,12</b>
		908101	<b>9,25</b>
ESCUDO GOMA POMO ELEVACION	25/35	908101	<b>9,25</b>
ESCUDO TERMOSTATO		901281	<b>4,80</b>
FILTRO RESIDUOS	10	901102	<b>45,28</b>
	12/17	901103	<b>50,31</b>
	25	901104	<b>55,63</b>
	35	901105	<b>60,12</b>
GRIFO COMPLETO	FA-6	901101	<b>35,02</b>
	FA-8/10	901100	<b>40,10</b>
	3/4	907089	<b>40,43</b>
F-5	907088	<b>77,91</b>	
GRIFO FREIDORA 1 1/4"		901372	<b>41,35</b>
GRIFO FREIDORA 3/4" PALANCA		901373	<b>17,57</b>
GRIFO FREIDORA 3/4" PALOMILLA		901371	<b>18,82</b>
GRIFO	FH-10	901374	<b>33,78</b>
INTERRUPTOR GENERAL 32A		901405	<b>129,74</b>
INTERRUPTOR GENERAL 40A		901404	<b>150,25</b>
JUNTA CRISTAL NIVEL	10/17/25/35	908257	<b>1,75</b>
JUNTA GRIFO 3/4" FREIDORA		908255	<b>1,23</b>
JUNTA GRIFO	5	908251	<b>2,04</b>
	FH-10	908250	<b>2,28</b>
JUNTA NIVEL	10/12/17/25/35	908253	<b>1,86</b>
	5	908252	<b>1,75</b>
JUNTA TORNILLO GRIFO	5	905225	<b>0,22</b>
JUNTA TORNILLO NIVEL	5/6	905226	<b>0,22</b>
MANDO INTERRUPTOR		901510	<b>18,34</b>
MANGO CESTA	12/17/25	907087	<b>24,28</b>
	4/6/8/10	907086	<b>23,99</b>
	5	907081	<b>10,28</b>
MANGO GRIFO	5	901521	<b>13,60</b>
MANOPLA TERMOSTATO FREIDORA		901504	<b>4,91</b>
MINICONTACTOR 1NA 230V AC		901162	<b>44,19</b>
MINICONTACTOR 1NC 230V AC		901163	<b>44,19</b>
NIVEL COMPLETO	10/12/17	907032	<b>55,63</b>
	25/35	907103	<b>117,70</b>
	5/6	907006	<b>38,48</b>
PASACABLE CABEZALES	FH	901622	<b>8,81</b>
PASACABLE	5/6/8/10	901620	<b>1,86</b>
PASADOR INOX 2,5x8 MANGO GRIFO		905359	<b>1,11</b>
PATA FREIDORA		905842	<b>12,14</b>
PILOTO REDONDO AMBAR 400V		901580	<b>3,58</b>
PILOTO REDONDO INCOLORO 400V		901582	<b>3,58</b>

	MOD.	REF.	€
PILOTO REDONDO ROJO 400V		901581	<b>3,58</b>
PILOTO REDONDO ROJO	5	901583	<b>3,54</b>
		907080	<b>5,93</b>
PLASTICO MANGO CESTA FREIDORA	LUX	907085	<b>9,42</b>
POMO ELEVACION COMPLETO	5/6	907007	<b>17,82</b>
POMO ELEVACION PLASTICO	25/35	908367	<b>6,74</b>
POMO MANDO ELEVACION COMPLETO	25/35	907105	<b>70,21</b>
	10/12/17	907116	<b>71,52</b>
POMO TAPA FREIDORA		908020	<b>4,95</b>
PRENSAESTOPA CABEZAL FREIDORA		908370	<b>2,28</b>
RACORD 3/4" GRIFO	FA-8/10	905408	<b>11,92</b>
	12/17 7000W 400V	901678	<b>183,93</b>
	F10 4000W	901690	<b>68,52</b>
	FA10 9000W 400V MAX	901707	<b>259,13</b>
	FAR 10 10000W	901688	<b>279,66</b>
	FAR 12/17 17000W	901686	<b>450,29</b>
	FAR 25 25000W	901687	<b>577,70</b>
	10 6000W 400V	901684	<b>216,94</b>
	10/12/17 6000W 230V	901677	<b>133,70</b>
RESISTENCIA	25 15000W	901680	<b>415,02</b>
	35 25000W	901681	<b>685,98</b>
	4 2000W	901685	<b>66,96</b>
	5 2000W	901701	<b>43,86</b>
	6 3000W	901689	<b>47,40</b>
	8/FA10 4000W	901691	<b>68,52</b>
	FA-10 6000W 230V MAX	901705	<b>193,60</b>
	FA-10 6000W 400V MAX	901706	<b>285,37</b>
	FA-10 9000W 400V MAX	901707	<b>259,13</b>
RODILLO RESISTENCIA COMPLETO	25/35	907018	<b>22,54</b>
SOPORTE CABEZAL	FA-4/6/8/10	905429	<b>7,87</b>
SOPORTE FIJACION CABEZAL FREIDORA		905420	<b>18,53</b>
SOPORTE FIJACION CESTA		905417	<b>92,00</b>
TAPA CAJA CABEZAL	5	905451	<b>6,19</b>
	F/FAP-10	907010	<b>24,39</b>
	17/12	907011	<b>31,44</b>
TAPA COMPLETA	25	907012	<b>53,51</b>
	35	907013	<b>73,47</b>
	FA-6/8/10	907009	<b>24,39</b>
TAPA	5	905116	<b>8,37</b>
TERMOSTATO COMPLETO FREIDORA	E20	907110	<b>30,25</b>
TERMOSTATO SEGURIDAD	5	901771	<b>16,60</b>
TERMOSTATO SEGURIDAD FREIDORA		901770	<b>18,49</b>
ZOCALO	5	905361	<b>9,54</b>

 (+34) 936 358 758

 (+34) 608 299 107

 pedidos@movilfritofficial.com

[www.movilfritofficial.com](http://www.movilfritofficial.com)



VITRINAS  
DISPLAY CASES  
VITRINES

	MOD.	REF.	€
BANDEJA GASTRONORM 1/3		916810	21,06
CRISTAL CALENTADOR	IRON 4	918381	244,43
	IRON 6	918379	253,35
CRISTAL ESTANTE TRANSPARENTE	CUB 4 2P	916942	82,23
	CUB 6 2P	916939	77,32
	CUB 8 2P	916967	105,40
	IRON 4 2P	916901	91,71
CRISTAL ESTANTE EXPOSITOR 390	IRON 6 2P	914002	115,87
	IRON 8 2P	914003	139,85
	V4	919089	78,42
	V6	919090	83,31
CRISTAL EXPOSITOR PLANO	1P SUP/FRON/ESTAN	01224110	50,61
	2P FRONTAL	01224140	88,94
CRISTAL EXPOSITOR CURVO	1P	01224180	141,07
	2P	01224190	147,72
CRISTAL EXPOSITOR	IRON BLANCO 4 1P	919040	289,73
	IRON BLANCO 4 2P	919042	303,25
	IRON BLANCO 6 1P	919044	310,26
	IRON BLANCO 6 2P	919046	325,06
	IRON BLANCO 8 1P	919048	383,16
	IRON BLANCO 8 2P	919050	398,05
	IRON NEGRO 4 1P	916913	289,73
	IRON NEGRO 4 2P	916914	303,25
	IRON NEGRO 6 1P	916915	310,26
	IRON NEGRO 6 2P	916916	325,06
	IRON NEGRO 8 1P	916917	383,16
	IRON NEGRO 8 2P	916918	398,05
	IRON REMOTO 6	918380	263,42
	IRON REMOTO 6 2P	918382	281,35
IRON REMOTO 8	918385	298,53	
IRON REMOTO 8 2P	918383	328,21	
IRON ROJO 4 1P	919039	289,73	
IRON ROJO 4 2P	919041	303,25	
IRON ROJO 6 1P	919043	310,26	
IRON ROJO 6 2P	919045	325,06	
IRON ROJO 8 1P	919047	383,16	
IRON ROJO 8 2P	919049	398,05	
VECI/JADE 4	916819	223,27	
VECI/JADE 6	916820	235,00	
VECI/JADE 8	916821	259,14	
CRISTAL FRONTAL CALENTADOR	CUB 4	916948	85,83
	CUB 6	916950	122,05
CRISTAL FRONTAL NEGRO/BLANCO/ROJO	CUB 4 1P	916930	146,48
	CUB 4 2P	916940	145,21
	CUB 6 1P	916932	171,90
	CUB 6 12P	916937	185,01
CRISTAL FRONTAL EXPOSITOR 390	CUB 8 1P	916934	162,80
	CUB 8 2P	916965	184,49
CRISTAL MOTOR BLANCO/PLATA	V4 1P	919080	75,61
	V4 2P	919081	77,27
	V6 1P	919082	80,41
	V6 2P	919083	85,31
CRISTAL MOTOR BLANCO/PLATA	V8 1P	919084	96,75
	V8 2P	919085	99,31
		916826	101,43

	MOD.	REF.	€
CRISTAL SUPERIOR CALENTADOR	CUB 4	916949	109,23
	CUB 6	916951	121,93
CRISTAL SUPERIOR NEGRO/BLANCO/ROJO	CUB 4 1P/2P	916931	154,83
	CUB 6 1P/2P	916933	158,15
	CUB 8 1P/2P	916966	190,20
CRISTAL SUPERIOR EXPOSITOR 390	V4 1P/2P	919086	78,76
	V6 1P/2P	919087	83,72
	V8 1P/2P	919088	106,12
FUENTE ALIMENTACION LED 30 W		918554	25,10
INTERRUPTOR RECTANGULAR		916840	6,15
JUEGO PUERTAS	CUB/CALENT/NEUTRA 4	916784	37,53
	CUB/CALENT/NEUTRA 6	916785	37,91
	CUB/CALENT/NEUTRA 8	916786	44,93
	EXPOSITOR 1 PISO	916792	65,13
	EXPOSITOR 2 PISO	916793	87,05
	IRON 4 2P / CUB 4 2P (2022)	916794	57,86
	IRON 6 2P / CUB 6 2P (2022)	916795	62,00
	IRON 8 2P / CUB 8 2P (2022)	916796	67,57
	IRON/IRON2P/CALENT/ CUB2P 4	916842	28,95
	IRON/IRON2P/CALENT/ CUB2P 6	916851	35,40
IRON/IRON2P/CALENT/ CUB2P 8	916879	38,91	
VECI/JADE 4	916789	38,90	
VECI/JADE 6	916790	39,32	
VECI/JADE 8	916791	43,54	
JUEGO SOPORTE VITRINA (2 PIEZAS)		916872	111,21
KIT DESAGÜE VITRINA		905415	65,00
LATERAL EXPOSITOR	1 PISO CURVO	01224170	31,48
	1 PISO PLANO	01224120	32,99
	2 PISO CURVO	01224160	46,43
	2 PISO PLANO	01224150	45,60
	PLANO 1P DE 390mm	01224199	60,37
PLANO 2P DE 390mm	01224200	60,37	
LATERAL RANURADO	CUB 1P	918370	63,16
	CUB 2P	918377	75,52
	IRON 1P	918391	71,77
	IRON 2P	918394	85,17
LATERAL TRANSPARENTE	CUB 1P	918371	72,43
	CUB 2P	918378	83,07
	IRON 1P	918390	71,83
	IRON 2P	918393	85,17
MOTOR VENTILADOR 10W CON SOPORTE		918489	37,05
PARRILLA CUBA PLANA		918361	36,00
SOPORTE ESTANTE EXPOSITOR Derecho		14331150	2,37
SOPORTE ESTANTE EXPOSITOR Izquierdo	IRON/CUB 2P	914001	1,85
TERMOSTATO VITRINA CALENTADOR		918504	18,59
TERMOSTATO VITRINA	IRON/CUB	916986	78,29

	MOD.	REF.	€
TIRA LED	4	918551	38,97
	6	918552	49,95
	8	918553	61,94
	REMOTA/CALIENTE 4	918543	39,95
	REMOTA/CALIENTE 6	918544	51,94
REMOTA/CALIENTE 8	918545	63,94	
TOPE GOMA PIE		14340130	2,47



BRASA  
CHARCOAL  
BRAISE

	MOD.	REF.	€
CORTAFUEGOS EXTERNO		202802	405,00
CRISTAL PUERTA HORNO	HBR-4	202408	210,00
	HBR-6	202409	250,00
MESA HORNO		202800	1480,00
MUELLE PUERTA HORNO		202818	41,93
PALA ATIZADOR		202807	57,00
PARRILLA ACANALADA	BM-80 / BM-160	202412	345,00
PARRILLA ACANALADA INOX	HBR-6	202407	770,81
PARRILLA BESUGUERA		202806	58,00
PARRILLA PESCADO		202805	82,00
PARRILLA TOLVA	HBR-4	202413	175,00
	HBR-6	202414	280,00
PARRILLA VARILLA	HBR-4	202405	459,91
	HBR-6	202406	498,02
PINZA CON GUIA		202804	53,00
PLANCHA	BM80/ BM160	202821	210,00
POMO ELEVADOR PARRILLA		202813	25,88
REGULADOR TIRO EXTERNO		202803	298,00
SOMBRERO		202801	269,85
TERMOMETRO HORNO BRASA 500°C		202820	166,00



PLANCHAS  
BARBACOAS  
GRIDDLES  
BARBACUES  
PLANCHAS  
BARBECUES

	MOD.	REF.	€
ASLANTE ASA PLANCHA	PE-500 LUX	905487	2,03
ASA INOX PLANCHA	PE-500 LUX	905434	15,31
PIEDRA VOLCANICA 3KG BARBACOA		915025	23,32
POMO ELEVADOR PARRILLA		202813	25,88
RECOGEGRASAS PLANCHA	PE-500 LUX	905486	73,52
RESISTENCIA PLANCHA	PE-500 LUX	905435	69,95
TERMOPAR BARBACOA		202814	19,59
TERMOPAR PLANCHA		202815	17,06
TERMOSTATO REGULACION 300° C	PE-500 LUX	905431	41,17
VALVULA GAS PLANCHA-BARBACOA		202816	96,18
VALVULA GAS TERMOSTATICA PLANCHA		202817	150,31

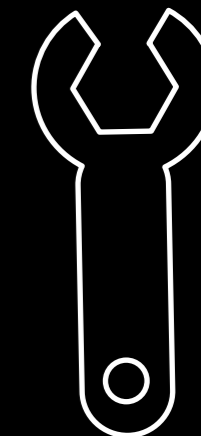

(+34) 936 358 758

(+34) 608 299 107

pedidos@movilfritofficial.com

www.movilfritofficial.com



# INDICE DE REFERENCIAS

REF.	PAG.	REF.	PAG.	REF.	PAG.	REF.	PAG.	REF.	PAG.	REF.	PAG.	REF.	PAG.					
300	MOTOR LADO CONTRARIO	47-49-51-57-59-61-63-65	32	157383	DC-8+8 S/Grifo	16	158301	FA-COM 10+10 4+9 C/Grifo	20	306988	CUB COLD 6 2P Blanco	62	308027	CUB 6 SUSHI CUBA PLANA Rojo	58	877034	IRON 6 CUBA PLANA Negro	46
107066	F-10 230	32	157384	DC-10 C/Grifo	16	158302	FA-COM 10+10 6+9 C/Grifo	20	306989	CUB COLD 6 2P Rojo	62	308028	CUB 8 SUSHI CUBA PLANA Rojo	58	877035	IRON 8 CUBA PLANA Negro	46	
107067	F-10+10 230	32	157385	DC-10+10 C/Grifo	16	158500	FA-COM 10(x3) 4(x3) S/Grifo	20	306990	CUB 4 CUBA PLANA Negro	56	308030	CUB SELF-SERVICE V4	54	877036	IRON 4 CUBA PLANA Rojo	46	
107070	FP-10 230	32	157386	DC-10 S/Grifo	16	158501	FA-COM 10(x3) (2)4+(1)6 S/Grifo	20	306991	CUB 6 CUBA PLANA Negro	56	308031	CUB SELF-SERVICE V6	54	877037	IRON 6 CUBA PLANA Rojo	46	
107071	FP-10+10 230	32	157387	DC-10+10 S/Grifo	16	158502	FA-COM 10(x3) (1)4+(2)6 S/Grifo	20	306992	CUB 8 CUBA PLANA Negro	56	308032	CUB SELF-SERVICE V8	54	877038	IRON 8 CUBA PLANA Rojo	46	
107306	FH-10 230	34	157388	DC-8 C/Grifo	16	158503	FA-COM 10(x3) (2)4+(1)9 S/Grifo	20	306993	CUB 4 CUBA PLANA Blanco	56	402025	900 INOX DIGITAL	112	877039	IRON 4 CUBA PLANA Blanco	46	
107307	FH-10 400	34	157389	DC-8+8 C/Grifo	16	158504	FA-COM 10(x3) (1)4+(2)9 S/Grifo	20	306994	CUB 6 CUBA PLANA Blanco	56	402026	900 INOX MANUAL	112	877040	IRON 6 CUBA PLANA Blanco	46	
107308	FH-10+10 230	34	157399	FA-4 S/Grifo	14	158505	FA-COM 10(x3) 6(x3) S/Grifo	20	306995	CUB 8 CUBA PLANA Blanco	56	440030	TM1	106	877041	IRON 8 CUBA PLANA Blanco	46	
107309	FH-10+10 400	34	157400	FA-6 S/Grifo	14	158506	FA-COM 10(x3) (2)6+(1)9 S/Grifo	20	306996	CUB 4 CUBA PLANA Rojo	56	440031	TM1T	106	877042	IRON 4 SUSHI Negro	48	
107310	FH-17 230	34	157401	FA-6+6 S/Grifo	14	158507	FA-COM 10(x3) (1)6+(2)9 S/Grifo	20	306997	CUB 6 CUBA PLANA Rojo	56	440032	TM2	106	877043	IRON 6 SUSHI Negro	48	
107311	FH-17 400	34	157407	FAP-10	24	158508	FA-COM 10(x3) (1)4+(1)6+(1)9 S/Grifo	20	306998	CUB 8 CUBA PLANA Rojo	56	440033	TM2T	106	877044	IRON 8 SUSHI Negro	48	
107312	FH-17+17 230	34	157409	FAP-10+10	24	158509	FA-COM 10+10+10 9+9+9 S/Grifo	20	307000	CUB 4 Negro	56	440034	TCM-210	108	877045	IRON 4 SUSHI Rojo	48	
107313	FH-17+17 400	34	157410	FA-8 S/Grifo	14	158700	FA-COM 10+10+10 4+4+4 C/Grifo	20	307001	CUB 6 Negro	56	440035	TCM-375	108	877046	IRON 6 SUSHI Rojo	48	
107315	FH-25 400	34	157411	FA-8+8 S/Grifo	14	158701	FA-COM 10(x3) (2)4+(1)6 C/Grifo	20	307002	CUB 8 Negro	56	500010	FGS-8	38	877047	IRON 8 SUSHI Rojo	48	
107317	FH-25+25 400	34	157412	FA-10 C/Grifo	14	158702	FA-COM 10(x3) (1)4+(2)6 C/Grifo	20	307003	CUB 4 Blanco	56	500014	FGM-18	40	877048	IRON 4 SUSHI Blanco	48	
107318	FH-35 400	34	157413	FA-10+10 C/Grifo	14	158703	FA-COM 10(x3) (2)4+(1)9 C/Grifo	20	307004	CUB 6 Blanco	56	500015	FGM-18+18	40	877049	IRON 6 SUSHI Blanco	48	
107320	FH-35+35 400	34	157414	FA-10 MAX 400 C/Grifo	14	158704	FA-COM 10(x3) (1)4+(2)9 C/Grifo	20	307005	CUB 8 Blanco	56	500016	FGS-10 MAX	38	877050	IRON 8 SUSHI Blanco	48	
108080	FP-10+10+10 230	36	157415	FA-10+10 MAX 400 C/Grifo	14	158705	FA-COM 10(x3) 6(x3) C/Grifo	20	307006	CUB 4 Rojo	56	500017	FGS-10+10 MAX	38	877051	IRON 4 SUSHI CUBA PLANA Negro	48	
108100	F-10+10+10 230	36	157418	FAP-17 230	24	158706	FA-COM 10(x3) (2)6+(1)9 C/Grifo	20	307007	CUB 6 Rojo	56	500018	FGM-24	40	877052	IRON 6 SUSHI CUBA PLANA Negro	48	
108200	FH-10+10+10 230	36	157419	FAP-17+17 230	24	158707	FA-COM 10(x3) (1)6+(2)9 C/Grifo	20	307008	CUB 8 Rojo	56	500019	FGM-24+24	40	877053	IRON 8 SUSHI CUBA PLANA Negro	48	
108201	FH-10+10+10 400	36	157420	FAP-17 400	24	158708	FA-COM 10(x3) (1)4+(1)6+(1)9 C/Grifo	20	307009	CUB 4 REMOTA Negro	56	606300	FREIDORA ELECTRICA FEM-10	84	877054	IRON 4 SUSHI CUBA PLANA Rojo	48	
108400	FH-17+17+17 230	36	157423	FAP-17+17 400	24	158709	FA-COM 10(x3) 9(x3) C/Grifo	20	307010	CUB 6 REMOTA Negro	56	606301	FREIDORA ELECTRICA FEM-10+10	84	877055	IRON 6 SUSHI CUBA PLANA Rojo	48	
108401	FH-17+17+17 400	36	157424	FAP-10 MAX 230	24	202100	HBR-4	76	307011	CUB 8 REMOTA Negro	56	606302	FREIDORA GAS FGM-10	84	877056	IRON 8 SUSHI CUBA PLANA Rojo	48	
117054	LUX 5	116	157425	FAP-10+10 MAX 230	24	202102	HBR-6	76	307012	CUB 2 2P REMOTA Negro	60	606303	FREIDORA GAS FGM-10+10	84	877057	IRON 4 SUSHI CUBA PLANA Blanco	48	
117055	LUX 5 + FILTRO	116	157426	FAP-10 MAX 400	24	202103	HBR-4 PRO	76	307013	CUB 6 2P REMOTA Negro	60	606320	COCINA GAS 2 FUEGOS CGM-2	84	877058	IRON 6 SUSHI CUBA PLANA Blanco	48	
156200	FAP-10+10+10 230	30	157427	FAP-10+10 MAX 400	24	202105	HBR-6 PRO	76	307014	CUB 8 2P REMOTA Negro	60	606321	COCINA GAS 2 FUEGOS CGM-4	84	877059	IRON 8 SUSHI CUBA PLANA Blanco	48	
156220	FAP-10+10+10 MAX 230	30	157430	FAP-12 230	24	202109	HBA-60	74	307026	EXPOSITOR 4 NEUTRO 1P F 390	69	606330	FRY TOP GAS FTGM-40	84	877060	IRON 4 2P CUBA PLANA Negro	50	
156221	FAP-10+10+10 MAX 400	30	157431	FAP-12+12 230	24	202110	HBA-30	74	307027	EXPOSITOR 6 NEUTRO 1P F 390	69	606331	FRY TOP ELECTRICO FTEM-40	84	877061	IRON 6 2P CUBA PLANA Negro	50	
156250	FAH-10+10+10 230	30	157432	FAP-12 400	24	202119	BM-50	78	307028	EXPOSITOR 8 NEUTRO 1P F 390	69	606332	FRY TOP GAS FTGM-80	84	877062	IRON 8 2P CUBA PLANA Negro	50	
156251	FAH-10+10+10 400	30	157433	FAP-12+12 400	24	202120	BM-80	78	307029	EXPOSITOR 4 NEUTRO 2P F 390	69	606333	FRY TOP ELECTRICO FTEM-80	84	877063	IRON 4 2P CUBA PLANA Blanco	50	
156330	FAH-12+12+12 230	30	157434	FAP-25 400	24	202121	BM-160	78	307030	EXPOSITOR 6 NEUTRO 2P F 390	69	606334	FRY TOP GAS FTGM-40 CROMO	84	877064	IRON 6 2P CUBA PLANA Negro	50	
156331	FAH-12+12+12 400	30	157435	FAP-25+25 400	24	202800	MESA HORNO	75-77	307031	EXPOSITOR 8 NEUTRO 2P F 390	69	606335	FRY TOP GAS FTGM-80 CROMO	84	877065	IRON 8 2P CUBA PLANA Blanco	50	
156340	FAP-12+12+12 230	30	157436	FAP-35 400	24	202801	SOMBREIRO	75-77	307069	CUB 4 2P Negro	60	606340	BARBACOA BGM-40	84	877066	IRON 4 2P CUBA PLANA Rojo	50	
156341	FAP-12+12+12 400	30	157437	FAP-35+35 400	24	202802	CORTAFUEGOS EXTERNO	75-77	307070	CUB 6 2P Negro	60	606341	BARBACOA BGM-80	84	877067	IRON 6 2P CUBA PLANA Blanco	50	
156430	FAH-17+17+17 230	30	157500	FA-10 S/Grifo	14	202803	REGULADOR DE TIRO EXTERNO	75-77	307071	CUB 8 2P Negro	60	606350	CUECEPASTAS CPEM-40	84	877068	IRON 8 2P CUBA PLANA Rojo	50	
156431	FAH-17+17+17 400	30	157501	FA-10+10 S/Grifo	14	202805	PARRILLA PESCADO	75-77-79	307072	CUB 6 2P CUBA PLANA Negro	60	606351	CUECEPASTAS CPGM-40	84	877069	IRON 6 2P CUBA PLANA Blanco	50	
156432	FAH-17+17+17 230	30	157502	FA-10 MAX 230 S/Grifo	14	202806	PARRILLA BESUGUERA	75-77-79	307073	CUB 8 2P CUBA PLANA Negro	60	606360	MANTENEDOR FRITOS MFE-40	84	877070	IRON 8 2P CUBA PLANA Rojo	50	
156433	FAH-17+17+17 400	30	157503	FA-10+10 MAX 230 S/Grifo	14	202821	PLANCHA LISA	79	307074	CUB 4 2P CUBA PLANA Negro	60	640003	FILTRO DE ACEITE	13	901100	FILTRO DE RESIDUOS	15-17-19-21	
156450	FAP-17+17+17 230	30	157506	FA-8 C/Grifo	14	203023	PEM-40	88	307075	CUB 4 2P Blanco	60	640004	CARTON PARA FILTRO DE ACEITE	13	901101	FILTRO DE RESIDUOS	15-17-19-21	
156451	FAP-17+17+17 400	30	157507	FA-8+8 C/Grifo	14	203024	PEM-60	88	307076	CUB 6 2P Blanco	60	640005	CALIDAD ACEITE	12				
157317	FAR-12 400	28	157509	FA-20 230	14	203030	PE 500 LUX	118	307077	CUB 8 2P Blanco	60	640006	TIRAS CALIDAD ACEITE	12				
157318	FAR-12+12 400	28	157510	FA-16 400	14	203047	PGM-40	90	307078	CUB 4 2P Rojo	60	807094	IRON 4 CALENTADOR Baño María	52	901102	FILTRO DE RESIDUOS	25-27-29-31-33-35-37	
157319	FAR-10+10 400	28	157511	FA-30 400	14	203048	PGM-60	90	307079	CUB 6 2P Rojo	60	807095	IRON 6 CALENTADOR Baño María	52				
157320	FAR-10 400	28	157600	FA-8 MAX 230 S/Grifo	14	203049	PGM-80	90	307080	CUB 8 2P Rojo	60	807096	CUB 4 CALENTADOR Baño María	66				
157321	FAR-17 400	28	157601	FA-8+8 MAX 230 S/Grifo	14	203053	PGR-45	95	307081	CUB 4 2P CUBA PLANA Blanco	60	807097	CUB 6 CALENTADOR Baño María	66	901103	FILTRO DE RESIDUOS	25-27-29-31-35-37	
157322	FAR-17+17 400	28	157602	FA-8 MAX 400 S/Grifo	14	203054	PGR-65	95	307082	CUB 6 2P CUBA PLANA Blanco	60	857398	FA-4+4 S/Grifo	14				
157324	FAR-25 400	28	157603	FA-8+8 MAX 400 S/Grifo	14	203055	PGR-85	95	307083	CUB 8 2P CUBA PLANA Blanco	60	860000	VITRINA AGATA VAR	44	901104	FILTRO DE RESIDUOS	25-27-29-35	
157325	FAR-25+25 400	28	157604	FA-10 MAX 400 S/Grifo	14	203062	PGC-45	94	307084	CUB 4 2P CUBA PLANA Rojo	60	860001	VITRINA AGATA VAN	44	901105	FILTRO DE RESIDUOS	25-27-29-35	
157326	FARP-10 400	28	157605	FA-10+10 MAX 400 S/Grifo	14	203063	PGC-65	94	307085	CUB 6 2P CUBA PLANA Rojo	60	876909	IRON 6 REMOTA Negro	46				
157327	FARP-10+10 400	28	157620	FA-8 MAX 230 C/Grifo	14	203064	PGC-85	94	307086	CUB 8 2P CUBA PLANA Rojo	60	876910	IRON 8 REMOTA Negro	46				
157328	FARP-17 400	28	157621	FA-8+8 MAX 230 C/Grifo	14	203095	BM-35	102	308000	CUB TOP 4 Negro	64	876912	IRON 6 REMOTA PLANA Negro	46	905415	KIT DESAGÜE	47-49-51-57-59-61-63-65	
157329	FARP-17+17 400	28	157622	FA-8 MAX 400 C/Grifo	14	203096	BM-60	102	308001	CUB TOP 4 Blanco	64	876913	IRON 8 REMOTA PLANA Negro	46				
157330	FARP-25 400	28	157623	FA-8+8 MAX 400 C/Grifo	14	203097	BM-90	102	308002	CUB TOP 4 Rojo	64	876914	IRON 6 2P REMOTA PLANA Negro	50				
157331	FARP-25+25 400	28	157624	FA-10 MAX 400 C/Grifo	14	203098	ECOM 1 FUEGO	98	308003	CUB TOP 6 Negro	64	876915	IRON 8 2P REMOTA PLANA Negro	50	905416	CAJÓN DE VACIADO	25-27-29-31-35-37	
157332	FARP-12 400	28	157625	FA-10+10 MAX 400 C/Grifo	14	203099	ECOM 2 FUEGOS	98	308004	CUB TOP 6 Blanco	64	876916	IRON 6 2P REMOTA Negro	50				

# CONDICIONES DE VENTA



## PEDIDOS

Los pedidos deberán dirigirse a nuestras instalaciones centrales de INDUSTRIA 90, S.L. y MOVILFRIT, S.L., y deberán ser siempre por escrito vía email a pedidos@movilfritofficial.com o web en www.movilfritofficial.com, para que quede constancia tangible y se eliminen errores de transcripción de los mismos.

Una vez efectuada la expedición los pedidos no podrán anularse. Queda reservado el derecho de no admitir pedidos a aquellos clientes que hayan incumplido anteriores contratos.

## PORTES

Los portes serán pagados a partir de un pedido mínimo de 450 euros, impuestos a parte.

Cuando reciban la mercancía se debe revisar su excelente estado tanto externamente como internamente. Se debe notificar cualquier defecto o devolver dicha mercancía directamente al transportista por cualquier anomalía encontrada. El pendiente de revisión ha quedado sin efecto y la mercancía se debe revisar en el momento de la recepción delante del chofer. De lo contrario, no podrá procesarse cualquier incidencia a posteriori.

Los gastos de transporte incluyen una única entrega, en caso de no poder ser entregada por no estar en el local el gasto adicional de volver a entregar corre a cargo del cliente.

## CONDICIONES DE PAGO

El pago de las facturas se realizará al contado salvo que se otorgue crédito al cliente, en cuyo caso se efectuará el pago en la forma y lugar acordado.

Para pedidos inferiores a 300€ netos, el pago se realizará mediante transferencia bancaria a la aceptación del pedido.

El pago de los recambios se realizará mediante transferencia bancaria a la aceptación del pedido.

Si antes o durante la tramitación de un pedido se produjese un incumplimiento de pago, se podrá demorar la entrega de la mercancía mientras el comprador no anticipe el pago de los mismos.

## EMBALAJE

El embalaje estándar de INDUSTRIA 90, S.L. y MOVILFRIT, S.L. está incluido en los precios, los embalajes marítimos y especiales se cargarán en factura.

## PRECIOS

Los precios que figuran en la presente tarifa son Precios Venta Público en euros y en nuestras instalaciones centrales. No incluyen la instalación ni puesta en marcha del material.

INDUSTRIA 90, S.L. y MOVILFRIT, S.L. se reserva el derecho de modificar los precios sin previo aviso. Esta tarifa anula a todas las anteriores.

## GARANTIA

La garantía será la establecida según la ley vigente, 1 año en producto industrial y 2 años en producto doméstico, cubriendo solamente los defectos de fabricación quedando excluido la mala o indebida utilización del producto por el usuario.

Las indemnizaciones, desplazamientos y mano de obra no están cubiertas por esta garantía.

INDUSTRIA 90, S.L. y MOVILFRIT, S.L. se reserva el derecho de solicitar el envío de la pieza o piezas a sustituir sin cargo y a portes pagados para su comprobación.

## NO GARANTIA

- Si el uso del producto no ha sido de acuerdo a las instrucciones contenidas en el manual de instrucciones.
- Si el producto ha sido usado fuera de su capacidad, haya sido golpeado o cualquier problema atribuible al cliente.
- Si ha sido reparado o modificado por personas no autorizadas por nuestro SERVICIO TECNICO o DISTRIBUIDOR.
- Si se han utilizado líquidos o productos que puedan causar daño al producto.
- Si hay o ha habido una instalación incorrecta.
- Utilización de piezas no originales.

## PROCESO EN LA GARANTIA

Para tramitar una solicitud de garantía es preciso cumplimentar la documentación previa.

Una vez aceptada la garantía sólo se mandará sin cargo las piezas solicitadas si el cliente tiene las piezas defectuosas preparadas para su recogida en el momento de la entrega. De lo contrario se deberá abonar previamente las piezas solicitadas para proceder a su envío y una vez el cliente nos envíe a portes pagados las piezas defectuosas se procederá a su verificación y si procede a su correspondiente abono en cuenta.

Todos los abonos que se realicen quedarán en cuenta para posteriores compras.

## DEVOLUCIONES

No se admitirán devoluciones sin previa autorización de INDUSTRIA 90, S.L. y MOVILFRIT, S.L.. Todos los gastos ocasionados por la devolución de la mercancía serán a cargo del cliente. La mercancía debe ser devuelta con su embalaje original. No se aceptará mercancía sin su embalaje original o que haya sufrido cualquier uso o manipulación. Del importe de su devolución, se deducirá en concepto de gastos de recepción, prueba o inspección, independientemente de que en cada caso se pueda hacer otra valoración.

## PROPIEDAD DE LA MERCANCIA

Toda mercancía que no esté totalmente pagada es propiedad de INDUSTRIA 90, S.L. y MOVILFRIT, S.L. aunque permanezca en stock del comprador.

## JURISDICCION

En caso de litigio sólo serán competentes los tribunales de Barcelona.

INDUSTRIA 90, S.L. y MOVILFRIT, S.L., SE RESERVA EL DERECHO DE EFECTUAR VARIANTES DE DISEÑO Y ACABADOS SIN PREVIO AVISO ASÍ COMO CARACTERÍSTICAS TÉCNICAS.

ESTA TARIFA ANULA Y SUSTITUYE A TODAS LAS ANTERIORES.